

V A C O N
C X / C X L / C X S
F R E Q U E N C Y C O N V E R T E R S

***Pump control
with autochange***

Subject to changes without notice.

F O R S M O O T H C O N T R O L



vacon

Pump control with autochange Application

(par. 0.1 = 0)

CONTENTS

1	General	3
2	Control I/O	3
3	Control signal logic	4
4	Parameter group 0	5
5	Basic parameters, Group 1	6
	5.1 Parameter table, Group 1	6
	5.2 Description of Group1 parameters	7
6	Special parameters, Groups 2—10	10
	6.1 Parameter tables, Groups 2—10	10
	6.2 Description of Groups 2—10 param.	21
7	I/O-expander with pump and fan control	59
8	Commissioning of pump and fan control	62
9	Monitoring data	63
10	Panel reference	64

1 General

Pump and fan control with autochange can be selected by setting the value of parameter 0.1 to 0.

The application can be used to control one variable speed drive and 0-4 auxiliary drives. Additionally the motor connected to the frequency converter and the start order of the auxiliary drives can be changed with the autochange function and external relay system. The PI-controller of the frequency

converter controls the speed of the variable speed drive and gives control signals to Start and Stop auxiliary drives to control the total flow.

The application has two control sources on I/O terminals. Source A is Pump and fan control and source B is direct frequency reference. The control source is selected with DIB6 input.

2 Control I/O

Note! Remember to connect CMA and CMB inputs

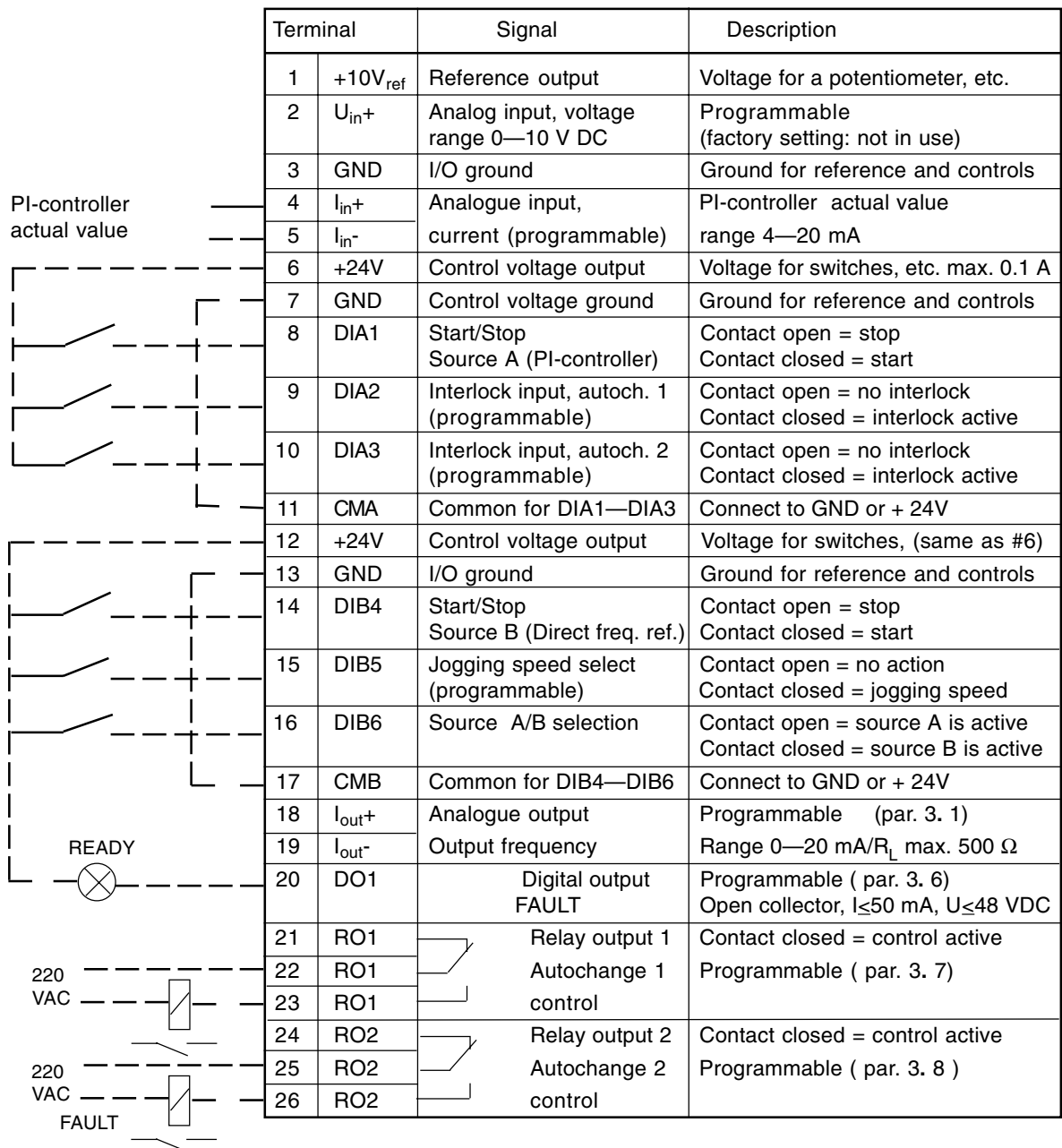

Figure 2-1 Default I/O configuration and connection example of the Pump and fan Control Application with autochange

3 Control signal logic

The logic of I/O-control signals and push button signals from the panel are presented in the figure 3-1.

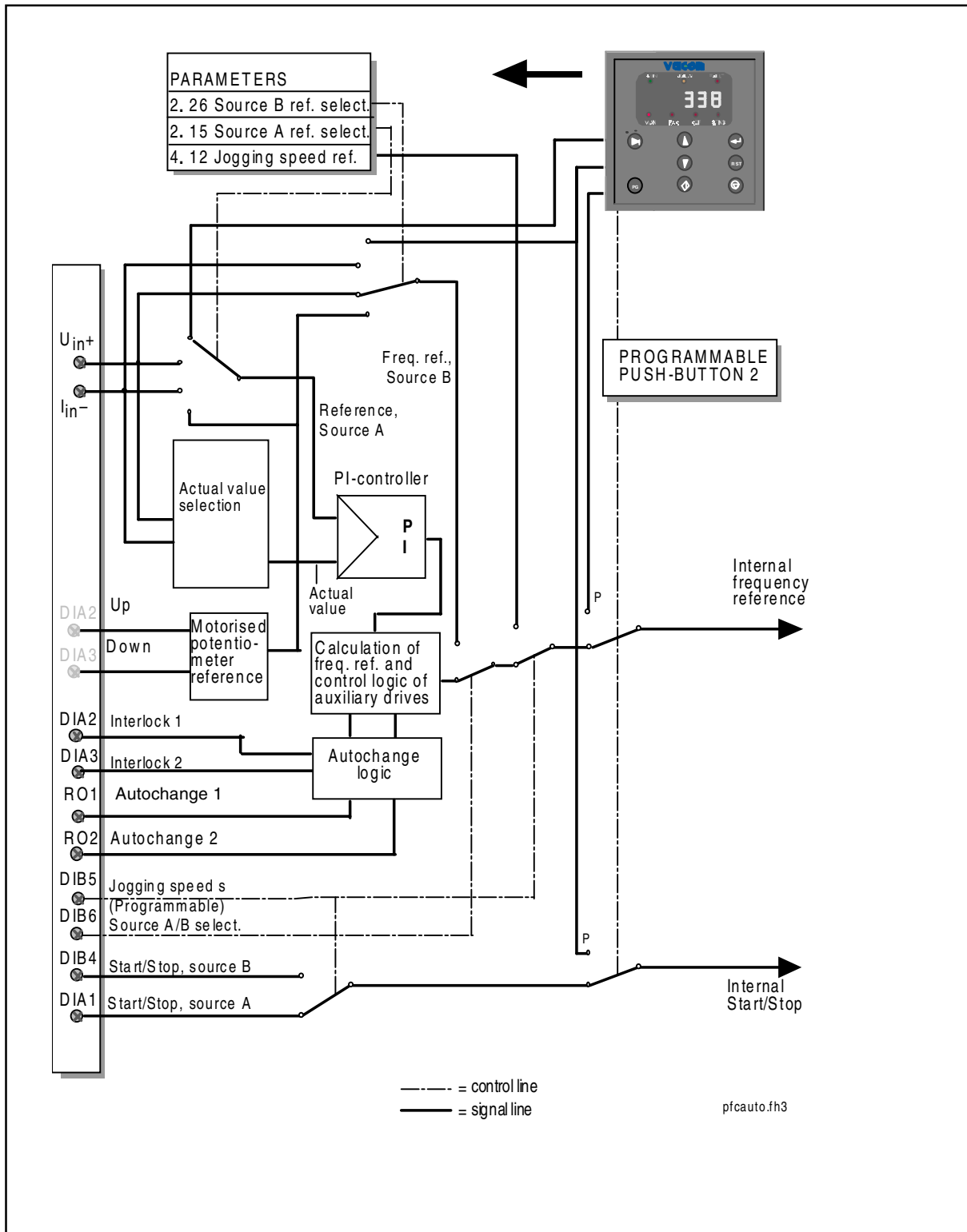

Figure 3-1 Control signal logic of the Pump and fan control Application. Switch positions shown correspond to the factory settings.

4 Parameter group 0

Number	Parameter	Range	Step	Default	Customer	Description
0.1	Application selection	0—7	1	0		0 = Pump and fan control with auto-change (loaded special application) 1 = Basic Application 2 = Standard Application 3 = Local / Remote Control Application 4 = Multi-step Speed Application 5 = PI-control Application 6 = Multi-purpose Control Application 7 = Pump and fan control Application
0.2	Parameter loading	0—5	1	0		0 = Loading ready / Select loading 1 = Load default setting 2 = Read up parameters to user's set 3 = Load down user's set parameters 4 = Read parameters up to the panel (possible only with graphical panel) 5 = Load down parameters from panel (possible only with graphical panel)
0.3	Language selection	0—1	1	0		0 = English 1 = Finnish 2 = Spanish

0.1 Application selection

With this parameter the active application can be selected. If the device has been ordered from the factory equipped with pump and fan control with autochange application this has been loaded to the unit as application 0. The application has also been set active in the factory. Check anyway that the value of the parameter 0.1 is zero when you want to use the pump and fan control with autochange application.

If the application is loaded to the device later it has to be set active always after loading by setting the value of parameter 0.1 to zero.

0.2 Parameter loading







See User's manual chapter 11.

0.3 Language

With this parameter the language of the graphical panel can be selected.

5 Basic parameters, Group 1

5.1 Parameter table, Group 1

Code	Parameter	Range	Step	Default	Custom	Description	Page
1. 1	Minimum frequency	0—120/500 Hz	1 Hz	10 Hz			6
1. 2	Maximum frequency	0—120/500 Hz	1 Hz	51 Hz		*)	6
1. 3	Acceleration time 1	0.1—3000 s	0.1 s	1 s		Time from f_{min} (1. 1) to f_{max} (1. 2)	6
1. 4	Deceleration time 1	0.1—3000 s	0.1 s	1 s		Time from f_{max} (1. 2) to f_{min} (1. 1)	6
1. 5	PI-controller gain	0-1000%	1 %	100%		0= No P-part in use	6
1. 6	PI-controller I-time	0—320.00 s	0.01s	10,00s		0= No I-part in use	6
1. 7	Current limit	0.1—2.5 x I_{nCX}	0.1 A	1.5 x I_{nCX}		Output current limit [A] of the unit	6
1. 8	U/f ratio selection 	0—2	1	0		0 = Linear 1 = Squared 2 = Programmable U/f ratio	6
1. 9	U/f optimization 	0—1	1	0		0 = None 1 = Automatic torque boost	7
1. 10	Nominal voltage of the motor 	180—690	1 V	230 V 400 V 500 V 690 V		Vacon range CX/CXL2 Vacon range CX/CXL/CXS4 Vacon range CX/CXL/CXS5 Vacon range CX6	8
1. 11	Nominal frequency of the motor 	30—500 Hz	1 Hz	50 Hz		f_n from the rating plate of the motor	8
1. 12	Nominal speed of the motor 	1—20000 rpm	1 rpm	1440 rpm **)		n_n from the rating plate of the motor	8
1. 13	Nominal current of the motor(I_{nMot}) 	2.5 x I_{nCX}	0.1 A	I_{nCX}		I_n from the rating plate of the motor	8
1. 14	Supply voltage 	180—250		230 V		Vacon range CX/CXL2	8
		380—440		400 V		Vacon range CX/CXL/CXS4	
		380—500		500 V		Vacon range CX/CXL/CXS5	
		525—690		690 V		Vacon range CX6	
1. 15	Parameter conceal	0—1	1	0		Visibility of the parameters: 0 = All parameter groups visible 1 = Only group 1 is visible	8
1. 16	Parameter value lock	0—1	1	0		Disables parameter changes: 0 = Changes enabled 1 = Changes disabled	8

Note!  =Parameter value can be changed only when the frequency converter is stopped.

*) If 1. 2 > motor synchr. speed, check suitability for motor and drive system
Selecting 120 Hz/500 Hz range see page 6-5.

***) Default value for a four pole motor and a nominal size frequency converter.

Table 5-1 Group 1 basic parameters.

5.2 Description of Group 1 parameters

1. 1, 1. 2 Minimum / maximum frequency

Defines frequency limits of the frequency converter.

The default maximum value for parameters 1. 1 and 1. 2 is 120 Hz. By setting 1. 2 = 120 Hz when the device is stopped (RUN indicator not lit) parameters 1. 1 and 1. 2 are changed to 500 Hz. At the same time the panel reference resolution is changed from 0.01 Hz to 0.1 Hz.

Changing the max. value from 500 Hz to 120 Hz is done by setting parameter 1. 2 = 119 Hz when the device is stopped.

NOTICE! Start frequency of the auxiliary drive is not conditional on maximum frequency because in the application start frequency and stop frequency of the auxiliary drives are scaled by the endower of the system.

1. 3, 1. 4 Acceleration time 1, deceleration time 1:

These limits correspond to the time required for the output frequency to accelerate from the set minimum frequency (par. 1. 1) to the set maximum frequency (par. 1. 2).

1. 5 PI-controller gain

This parameter defines the gain of the PI-controller.

If this parameter is set to 100%, a 10% change in error value causes the controller output to change by 10.0 Hz.

If the parameter value is set to 0 the PI-controller operates as I-controller.

1. 6 PI-controller I-time

Defines the integration time of the PI-controller.

1. 7 Current limit

This parameter determines the maximum motor current from the frequency converter. To avoid motor overloading set this parameter according to the rated current of the motor.

1. 8 U/f ratio selection

Linear: The voltage of the motor changes linearly with the frequency in the constant flux area from 0 Hz to the field weakening point (par. 6. 3) where the nominal voltage is supplied to the motor. See figure 6.4-1.

0 Linear U/f ratio should be used in constant torque applications.

This default setting should be used if there is no special demand for another setting.

Squared: The voltage of the motor changes following a squared curve form with the frequency in the area from 0 Hz to the field weakening point (par. 6. 3) where the nominal voltage is supplied to the motor.

1 See figure 6.4-1.

The motor runs undermagnetised below the field weakening point and produces less torque and electromechanical noise. Squared U/f ratio can be used in applications where torque demand of the load is proportional to the square of the speed, e.g. in centrifugal fans and pumps.

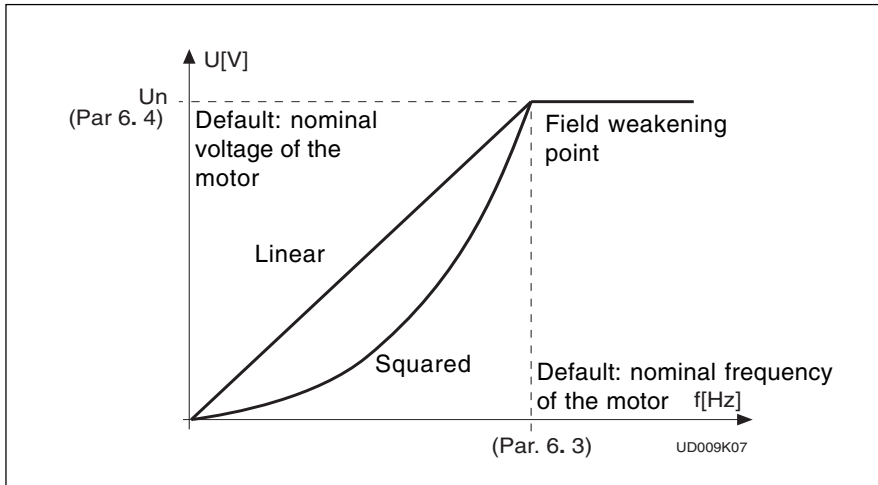

Figure 6.4-1 Linear and squared U/f curves.

Programm. The U/f curve can be programmed with three different points.
 U/f curve The parameters for programming are explained in the chapter 5.2.
 2 The programmable U/f curve can be used if the other settings do not satisfy the needs of the application. See figure 4-2.

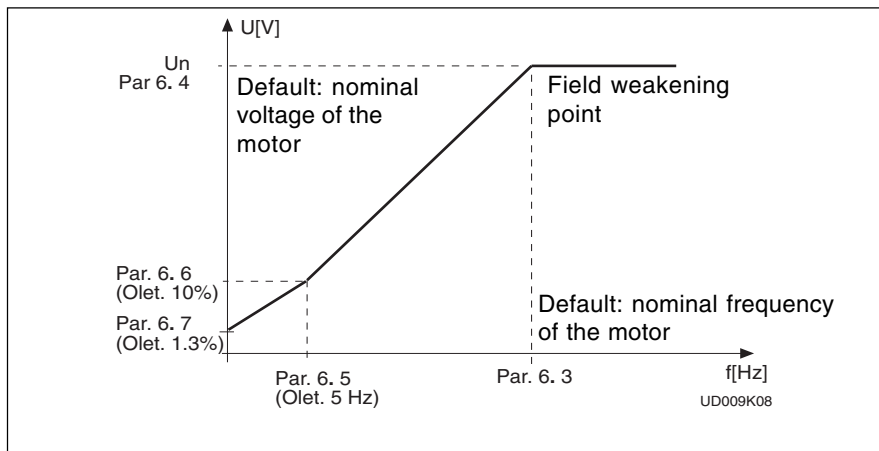

Figure 6.4-2 Programmable U/f curve.

1.9 U/f optimization

Automatic torque boost The voltage to the motor changes automatically which makes the motor to produce torque enough to start and run at low frequencies.
 boost The voltage increase depends on the motor type and power.

Automatic torque boost can be used in applications where starting torque is high due to starting friction, e.g. in conveyors.



In high torque - low speed applications - it is likely the motor will overheat. If the motor has to run a prolonged time under these conditions, special attention must be paid to cooling the motor. Use external cooling for the motor if the temperature tends to rise too high.

1. 10 Nominal voltage of the motor

Find this value U_n on the rating plate of the motor.

This parameter sets the Voltage at the field weakening point, parameter 6. 4, to $100\% \times U_{n_{motor}}$.

1. 11 Nominal frequency of the motor

Find this value f_n on the rating plate of the motor.

This parameter sets the field weakening point, parameter 6. 3, to the same value.

1. 12 Nominal speed of the motor

Find this value n_n on the rating plate of the motor.

1. 13 Nominal current of the motor

Find this value I_n on the rating plate of the motor.

1. 14 Supply voltage

Set parameter value according to the nominal voltage of the supply.

Values are pre-defined for CX/CXL2, CX/CXL/CXS4, CX/CXL/CXS5 and CX6 ranges, see table 6.4-1.

1. 15 Parameter conceal

Defines which parameter groups are available:

0 = All parameter groups are visible

1 = Only group 1 is visible

1. 16 Parameter value lock

Defines access to the changes of the parameter values:

0 = Parameter value changes enabled

1 = Parameter value changes disabled





6 Special parameters, Groups 2—9

6.1 Parameter tables



Group 2, Input signal parameters

Code	Parameter	Range	Step	Default	Custom	Description	Page
2.1	DIA2 function (terminal 9) 	0—10	1	11		0 = Not used 1 = Ext. fault, closing contact 2 = External fault, opening contact 3 = Run enable 4 = Acceler./deceler. time selection 5 = Reverse 6 = Jogging frequency 7 = Fault reset 8 = Acc./dec. operation prohibit 9 = DC-braking command 10 = Motor potentiometer UP 11 = Interlock input, autochange 1	20
2.2	DIA3 function (terminal 10) 	0—10	1	11		0 = Not used 1 = Ext. fault, closing contact 2 = External fault, opening contact 3 = Run enable 4 = Acceler./deceler. time selection 5 = Reverse 6 = Jogging frequency 7 = Fault reset 8 = Acc./dec. operation prohibit 9 = DC-braking command 10 = Motor potentiometer DOWN 11 = Interlock input, autochange 2	21
2.3	U _{in} signal range	0—2	1	0		0 = 0—10 V 1 = Custom setting range 2 = 2—10 V	21
2.4	U _{in} custom setting min.	0—100%	0.01%	0.00%			21
2.5	U _{in} custom setting max.	0—100%	0.01%	100.00%			21
2.6	U _{in} signal inversion	0—1	1	0		0 = Not inverted 1 = Inverted	21
2.7	U _{in} signal filter time	0—10s	0.01s	0.1s		0 = No filtering	21
2.8	I _{in} signal range	0—2	1	1		0 = 0—20 mA 1 = 4—20 mA 2 = Custom setting range	21
2.9	I _{in} custom setting minim.	0—100%	0.01%	0.00%			21
2.10	I _{in} custom setting maxim.	0—100%	0.01%	100.00%			21
2.11	I _{in} signal inversion	0—1	1	0		0 = Not inverted 1 = Inverted	22
2.12	I _{in} signal filter time 	0—10s	0.01s	0.1s		0 = No filtering	22
2.13	DIB5 function (terminal 15)	0—9	1	6		0 = Not used 1 = Ext. fault, closing contact 2 = External fault, opening contact 3 = Run enable 4 = Acc./dec. time selection 5 = Reverse 6 = Jogging speed 7 = Fault reset 8 = Acc./dec. operation prohibit 9 = DC-braking command 10 = PI-contr. reference selection 11 = Interlock input, autochange 3	22

Note!  = Parameter value can be changed only when the frequency converter is stopped (Continues)



Code	Parameter	Range	Step	Default	Custom	Description	Page
2.14	Motor potentiometer ramp time	0.1—2000.0 Hz/s	0.1 Hz/s	10.0 Hz/s			22
2.15	PI-controller reference signal (source A) 	0—6	1	2		0 = U _{in} signal (control board) 1 = I _{in} signal (control board) 2 = Set reference from the panel (reference r2) 3 = Signal from internal motor pot. 4 = Signal from internal motor pot. reset if Vacon unit is stopped 5 = Option board Ain1-signal 6 = Option board Ain2-signal 7 = Fieldbus signal	22
2.16	PI-controller actual value selection 	0—7	1	0		0 = Actual value1 1 = Actual 1 + Actual 2 2 = Actual 1 - Actual 2 3 = Actual 1 * Actual 2 4 = MIN(Actual1, Actual2) 5 = MAX(Actual1, Actual2) 6 = MEAN(Actual1, Actual2) 7 = SQRT(Act1) + SQRT(Act2)	23
2.17	Actual value 1 input 	0—4	1	2		0 = No 1 = U _{in} signal (control board) 2 = I _{in} signal (control board) 3 = Option board Ain1-signal 4 = Option board Ain2-signal 5 = Fieldbus signal	23
2.18	Actual value 2 input 	0—4	1	0		0 = No 1 = U _{in} signal (control board) 2 = I _{in} signal (control board) 3 = Option board Ain1-signal 4 = Option board Ain2-signal	23
2.19	Actual value 1 min scale	-320.00%—+320.00%	0.01%	0%		0% = no minimum scaling	23
2.20	Actual value 1 max scale	-320.00%—+320.00%	0.01%	100%		100% = no maximum scaling	23
2.21	Actual value 2 min scale	-320.00%—+320.00%	0.01%	0%		0% = no minimum scaling	23
2.22	Actual value 2 max scale	-320.00%—+320.00%	0.01%	100%		100% = no maximum scaling	23
2.23	Error value inversion	0—1	1	0		0 = No 1 = Yes	24
2.24	PI-controller reference value rise time	0—100.0 s	0.1 s	5 s		Time for reference value change from 0 % to 100 %	24
2.25	PI-controller reference value fall time	0—100.0 s	0.1 s	5 s		Time for reference value change from 100 % to 0 %	24

Note!  = Parameter value can be changed only when the frequency converter is stopped (Continues)

Code	Parameter	Range	Step	Default	Custom	Description	Page
2.26	Direct frequency reference, source B 	0—4	1	0		0 = U _{in} signal (control board) 1 = I _{in} signal (control board) 2 = Set reference from the panel (reference r1) 3 = Signal from internal motor pot. 4 = Signal from internal motor pot. reset if Vacon unit is stopped	24
2.27	Source B reference scaling minimum value	0—par.2.28	1 Hz	0 Hz		Selects the frequency that corresponds to the min. refer. signal	24
2.28	Source B reference scaling maximum value	par.2.28 —f _{max}	1 Hz	0 Hz		Selects the frequency that corresponds to the max. reference signal 0 = Scaling off >0 = Scaled maximum value	24
2.29	PI-controller reference 2 	0—7	1	7		0 = U _{in} signal (control board) 1 = I _{in} signal (control board) 2 = Set reference from the panel (reference r2) 3 = Signal from internal motor pot. 4 = Signal from internal motor pot. reset if Vacon unit is stopped 5 = Option board Ain1-signal 6 = Option board Ain2-signal 7 = Set reference from the panel (reference r3)	25
2.30	Option board Ain1 signal inversion	0—1	1	0		0 = Not inverted 1 = Inverted	25
2.31	Option board Ain1 signal filter time	0—10s	0.01s	0.1s		0 = No filtering	25
2.32	Option board Ain2 signal signal range	0—2	1	0		0 = 0—20 mA 1 = 4—20 mA 2 = 0—10 V	25
2.33	Option board Ain2 signal inversion	0—1	1	0		0 = Not inverted 1 = Inverted	25
2.34	Option board Ain2 signal filter time	0—10s	0.01s	0.1s		0 = No filtering	25

Note!  = Parameter value can be changed only when the frequency converter is stopped (Continues)

Group 3, Output and supervision parameters

Code	Parameter	Range	Step	Default	Custom	Description	Page
3.1	Analogue output function	0—15	1	1		0 = Not used Scale 100% 1 = O/P frequency (0— f_{max}) 2 = Motor speed (0—max. speed) 3 = O/P current (0— $2.0 \times I_{nCX}$) 4 = Motor torque (0— $2 \times T_{nCX}$) 5 = Motor power (0— $2 \times P_{nCX}$) 6 = Motor voltage (0—100% $\times U_{nM}$) 7 = DC-link volt. (0—1000 V) 8—10 = Not in use 11 = PI-controller reference value 12 = PI-controller actual value 1 13 = PI-controller actual value 2 14 = PI-controller error value 15 = PI-controller output	26
3.2	Analogue output filter time	0.01—10 s	0.01	1.00			26
3.3	Analogue output inversion	0—1	1	0		0 = Not inverted 1 = Inverted	26
3.4	Analogue output minimum	0—1	1	0		0 = 0 mA 1 = 4 mA	26
3.5	Analogue output scale	10—1000%	1%	100%			26
3.6	Digital output function 	0—30	1	3		0 = Not used 1 = Ready 2 = Run 3 = Fault 4 = Fault inverted 5 = Vacon overheat warning 6 = External fault or warning 7 = Reference fault or warning 8 = Warning 9 = Reversed 10 = Jogging speed selected 11 = At speed 12 = Motor regulator activated 13 = Output freq. limit superv. 1 14 = Output freq. limit superv. 2 15 = Torque limit supervision 16 = Reference limit supervision 17 = External brake control 18 = Control from I/O terminals 19 = Frequency converter temperature limit supervision 20 = Unrequested rotation direction 21 = External brake control inverted 22 = Analogue input supervision 22—26 = Not in use 27 = Autochange 3 control 28 = Auxiliary drive 1 start 29 = Auxiliary drive 2 start 30 = Auxiliary drive 3 start	27
3.7	Relay output 1 function 	0—31	1	26		0-25 = As parameter 3. 6 26 = Autochange 1 control 27 = Autochange 4 control 28-30 = As parameter 3. 6 31 = Aux. drive 4 start	27
3.8	Relay output 2 function 	0—30	1	26		0-25 = As parameter 3. 6 26 = Autochange 2 control 27 = Autochange 5 control 28-30 = As parameter 3. 6	28

Note!  = Parameter value can be changed only when the frequency converter is stopped. (Continues)

Code	Parameter	Range	Step	Default	Custom	Description	Page
3.9	Output freq. limit 1 supervision function	0—2	1	0		0 = No 1 = Low limit 2 = High limit	28
3.10	Output freq. limit 1 supervision value	0— f_{max} (par. 1.2)	0.1 Hz	0 Hz			28
3.11	Output freq. limit 2 supervision function	0—2	1	0		0 = No 1 = Low limit 2 = High limit	28
3.12	Output freq. limit 2 supervision value	0— f_{max} (par. 1.2)	0.1 Hz	0 Hz			28
3.13	Torque limit supervision function	0—2	1	0		0 = No 1 = Low limit 2 = High limit	28
3.14	Torque limit supervision value	0—200% x T_{nCX}	1%	100%			28
3.15	Active reference limit supervision function	0—2	1	0		0 = No 1 = Low limit 2 = High limit	29
3.16	Active reference limit supervision value	0— f_{max} (par. 1.2)	0.1 Hz	0 Hz			29
3.17	External brake off-delay	0—100.0 s	1	0.5 s			29
3.18	External brake on-delay	0—100.0 s	1	0.5 s			29
3.19	Frequency converter temperature limit supervision function	0—2	1	0		0 = No 1 = Low limit 2 = High limit	30
3.20	Frequency converter temperature limit	-10—+75°C	1	+40°C			30
3.21	I/O-expander board (opt.) analogue output content	0—7	1	3		See parameter 3.1	30
3.22	I/O-expander board (opt.) analogue output filter time	0.01—10 s	0.01	1.00		See parameter 3.2	30
3.23	I/O-expander board (opt.) analogue output inversion	0—1	1	0		See parameter 3.3	30
3.24	I/O-expander board (opt.) analogue output minimum	0—1	1	0		See parameter 3.4	30
3.25	I/O-expander board (opt.) analogue output scale	10—1000%	1	100%		See parameter 3.5	30
3.26	Analog output bias (basic control board)	0—100,00%	0,01%	0,00%			30
3.27	I/O-expander board (opt.) analogue output bias	0—100,00%	0,01%	0,00%			30
3.28	Analogue input supervision input	0—2	1	0		0 = U_{in} signal (control board) 1 = I_{in} signal (control board) 2 = Option board Ain1-signal 3 = Option board Ain2-signal	30
3.29	Analogue input supervision function	0—2	1	0		0 = No 1 = Low limit 2 = High limit	30
3.30	Analogue input supervision value	0—100%	0.1 %	0,0 %			30

Group 4, Drive control parameters







Code	Parameter	Range	Step	Default	Custom	Description	Page
4.1	Acc./dec. ramp 1 shape	0—10 s	0.1 s	0		0 = Linear >0 = S-curve acc./dec. time	31
4.2	Acc./dec. ramp 2 shape	0—10 s	0.1 s	0		0 = Linear >0 = S-curve acc./dec. time	31
4.3	Acceleration time 2	0.1—3000 s	0.1 s	10 s			31
4.4	Deceleration time 2	0.1—3000 s	0.1 s	10 s			31
4.5	Brake chopper 	0—1	1	0		0 = Brake chopper not in use 1 = Brake chopper in use 2 = External brake chopper	31
4.6	Start function	0—1	1	0		0 = Ramp 1 = Flying start	32
4.7	Stop function	0—1	1	0		0 = Coasting 1 = Ramp	32
4.8	DC-braking current	0.15—1.5 x I_{ncx} (A)	0.1 A	0.5 x I_{ncx}			32
4.9	DC-braking time at Stop	0—250.00 s	0.01 s	0 s		0 = DC-brake is off at Stop	33
4.10	Execute frequency of DC-brake during ramp stop	0.1 Hz	1.5 Hz				34
4.11	DC-brake time at Start	0—250.00 s	0.01 s	0 s		0 = DC-brake is off at Start	34
4.12	Jogging speed reference	f_{min} — f_{max} (1.1) (1.2)	0.1 Hz	10.0 Hz			34

Group 5, Prohibit frequency parameters

Code	Parameter	Range	Step	Default	Custom	Description	Page
5.1	Prohibit frequency range 1 low limit	0— f_{max} (1.2)	0.1 Hz	0 Hz			34
5.2	Prohibit frequency range 2 high limit	0— f_{max} (1.2)	0.1 Hz	0 Hz		0 = No prohibit frequency range	34
5.3	Prohibit frequency range 2 low limit	0— f_{max} (1.2)	0.1 Hz	0 Hz			34
5.4	Prohibit frequency range 2 high limit	0— f_{max} (1.2)	0.1 Hz	0 Hz		0 = No prohibit frequency range	34
5.5	Prohibit frequency range 3 low limit	0— f_{max} (1.2)	0.1 Hz	0 Hz			34
5.6	Prohibit frequency range 3 high limit	0— f_{max} (1.2)	0.1 Hz	0 Hz		0 = No prohibit frequency range	34

Note!  = Parameter value can be changed only when the frequency converter is stopped. (Continues)

Group 6, Motor control parameters

Code	Parameter	Range	Step	Default	Custom	Description	Page
6.1	Motor control mode 	0—1	1	0		0 = Frequency control 1 = Speed control	34
6.2	Switching frequency	1—16 kHz	0,1 kHz	10/3.6kHz		Dependant on kW	35
6.3	Field weakening point 	30—500 Hz	1 Hz	Param. 1.11			35
6.4	Voltage at field weakening point 	15—200% $\times U_{nmot}$	1%	100%			35
6.5	U/F-curve mid point frequency 	0—500 Hz	0,1 Hz	0 Hz			35
6.6	U/F-curve mid point voltage 	0—100% $\times U_{nmot}$	0.01%	0%			35
6.7	Output voltage at zero frequency 	0—100% $\times U_{nmot}$	0.01%	0%			35
6.8	Overvoltage controller 	0—1	1	1		0 = Controller is not operating 1 = Controller is in operation	36
6.9	Undervoltage controller	0—1	1	1		0 = Controller is not operating 1 = Controller is in operation	36

Group 7, Protections

Code	Parameter	Range	Step	Default	Custom	Description	Page
7.1	Response to reference fault	0—3	1	2		0 = No action 1 = Warning 2 = Fault, stop according to par 4.7 3 = Fault, stop always by coasting	36
7.2	Response to external fault	0—3	1	0		0 = No action 1 = Warning 2 = Fault, stop according to par 4.7 3 = Fault, stop always by coasting	36
7.3	Phase supervision of the motor	0—2	2	2		0 = No action 2 = Fault	36
7.4	Earth protection	0—2	2	2		0 = No action 2 = Fault	36
7.5	Motor thermal protection	0—2	1	2		0 = No action 1 = Warning 2 = Fault	37
7.6	Motor thermal protection break point current	50.0—150 % $\times I_{nMOTOR}$	1.0 %	100.0%			37
7.7	Motor thermal protection zero frequency current	10.0—150% $\times I_{nMOTOR}$	1.0 %	45.0%			38
7.8	Motor thermal protection time constant	0.5—300.0 minutes	0,5 min.			Default value is set according to motor nominal current	38
7.9	Motor thermal protection break point frequency	10—500 Hz	1 Hz	35 Hz			39

Code	Parameter	Range	Step	Default	Custom	Description	Page
7.10	Stall protection	0—2	1	1		0 = No action 1 = Warning 2 = Fault	39
7.11	Stall current limit	10.0—200% $\times I_{nMOTOR}$	1.0%	130.0%			40
7.12	Stall time	2.0—120 s	1.0 s	15.0 s			40
7.13	Maximum stall frequency	1— f_{max}	1 Hz	25 Hz			40
7.14	Underload protection	0—2	1	0		0 = No action 1 = Warning 2 = Fault	41
7.15	Underload prot., field weakening area load	20.0—150 % $\times T_{nMOTOR}$	1.0%	50.0%			41
7.16	Underload protection, zero frequency load	10.0—150.0% $\times T_{nMOTOR}$	1.0%	10.0%			41
7.17	Underload time	2.0—600.0 s	1.0 s	20.0s			41
7.18	Phase supervision of the supply voltage	0—2	2	2		0 = No action 2 = Fault	42
7.19	Termistor input of I/O-Expander	0—2	1	2		0 = No action 1 = Warning 2 = Fault	42
7.20	Fieldbus fault	0 - 2	1	2		0 = No action 1 = Warning 2 = Fault	







Group 8, Autorestart parameters

Code	Parameter	Range	Step	Default	Custom	Description	Page
8.1	Automatic restart: number of tries	0—10	1	2		0 = Not used	42
8.2	Automatic restart: trial time	1—6000 s	1 s	30 s			42
8.3	Automatic restart: start function	0—1	1	0		0 = Ramp 1 = Flying start	43
8.4	Automatic restart after undervoltage trip	0—1	1	1		0 = No 1 = Yes	43
8.5	Automatic restart after overvoltage trip	0—1	1	1		0 = No 1 = Yes	43
8.6	Automatic restart after overcurrent trip	0—1	1	1		0 = No 1 = Yes	43
8.7	Automatic restart after reference fault trip	0—1	1	1		0 = No 1 = Yes	43
8.8	Automatic restart after over/undertemperature fault trip	0—1	1	1		0 = No 1 = Yes	43

Group 9, Pump and fan control special parameters

Code	Parameter	Range	Stepl	Default	Custom	Description	Page
9.1	Number of aux. drives	0—4	1	1			44
9.2	Start frequency of auxiliary drive 1	f_{min} — 120/500	0.1 Hz	51.0 Hz		starting	44
9.3	Stop frequency of auxiliary drive 1	f_{min} — Par. 9.2	0.1 Hz	10.0 Hz		stopping	44
9.4	Start frequency of auxiliary drive 2	f_{min} — 120/500	0.1 Hz	51.0 Hz		starting	44
9.5	Stop frequency of auxiliary drive 2	f_{min} — Par. 9.4	0.1 Hz	10.0 Hz		stopping	44
9.6	Start frequency of auxiliary drive 3	f_{min} — 120/500	0.1 Hz	51.0 Hz		starting	44
9.7	Stop frequency of auxiliary drive 3	f_{min} — Par. 9.6	0.1 Hz	10.0 Hz		stopping	44
9.8	Start frequency of auxiliary drive 4	f_{min} — 120/500	0.1 Hz	51.0 Hz		Needs I/O-expander option board	44
9.9	Stop frequency of auxiliary drive 4	f_{min} — Par. 9.8	0.1 Hz	10.0 Hz		Needs I/O-expander option board	44
9.10	Start delay of the auxiliary drives	0—300.0 s	0.1 s	4.0 s			44
9.11	Stop delay of the auxiliary drives	0—300.0 s	0.1 s	2.0 s			44
9.12	Reference step after start of the 1 aux. drive	0—100.0 %	0.1 %	0.0 %		In % of actual value	45
9.13	Reference step after start of the 2 aux. drive	0—100.0 %	0.1 %	0.0 %		In % of actual value	45
9.14	Reference step after start of the 3 aux. drive	0—100.0 %	0.1 %	0.0 %		In % of actual value	45
9.15	Reference step after start of the 4 aux. drive	0—100.0 %	0.1 %	0.0 %		In % of actual value	45
9.16	Sleep level	0—120/500 Hz	0.1 Hz	10.0 Hz		Frequency below which the freq. of the speed controlled motor has go before starting the sleep delay counting (0.0 = not in use)	46
9.17	Sleep delay	0—3000.0 s	0.1 s	30.0 s		Time that the freq. has to be below par. 9.16 before stopping Vacon	46
9.18	Wake up level	0—100.0 %	0.1 %	25.0 %		Level of the actual value for restarting Vacon	46
9.19	Wake up function	0—3	1	0		0 = Wake up falling below the level Level % from actual max. value 1 = Wake up exceeding the level Level % from actual max. value 2 = Wake up falling below the level Level % from current reference 3 = Wake up exceeding the level Level % from current reference	46

Note!  =Parameter value can be changed only when the frequency converter is stopped. (Continues)

Code	Parameter	Range	Step	Default	Custom	Description	Page
9.20	PI-regulator bypass 	0—1	1	0		1 = PI-regulator bypassed	48
9.21	Input pressure measurement: input selection 	0—4	1	0		0 = Function not in use 1 = U_{in} signal (control board) 2 = I_{in} signal (control board) 3 = Option board Ain1-signal 4 = Option board Ain2-signal	49
9.22	Input pressure high limit	0—100,0%	0,1 %	30,0 %		Percents from the maximum of the input pressure measurement	49
9.23	Input pressure low limit	0—100,0%	0,1 %	20,0 %		Percents from the maximum of the input pressure measurement	49
9.24	Output pressure drop	0—100,0%	0,1 %	30,0 %		Value is percents from the maximum actual value	49
9.25	Frequency drop delay after starting an auxiliary drive 	0—300,0 s	0,1 s	0,0 s		0,0 = no delay 0,1 - 299,0 = delay value 300,0 = no frequency drop	50
9.26	Frequency increase delay after stopping an auxiliary drive 	0—300,0 s	0,1 s	0,0 s		0,0 = no delay 0,1 - 299,0 = delay value 300,0 = no frequency increase	50
9.27	Autochange mode 	0—2	1	2		0 = autochange off 1 = autochange only with auxiliary drives 2 = autochange with all drives	51
9.28	Autochange interval	0,1—3000 h	0,1 h	50,0 h		Elapsed time for autochange 0 = Test, interval 40 secs	52
9.29	Autochange level, auxiliary drives	0—4	1	0		Determines how many auxiliary drives can be running when autochange is started	53
9.30	Autochange level, variable speed drive frequency	0— f_{max}	0,1 Hz	40,0 Hz		Determines the level below which the frequency must be before the autochange can happen 0,0 Hz = autochange only in stop or sleep state	53
9.31	Autochange interlocks 	0—1	1	1		0 = not in use 1 = in use	54
9.32	Actual value special display minimum (n26)	0—32000	1	0			55
9.33	Actual value special display minimum (n26)	0—32000	1	100			55
9.34	Actual val. special disp. number of decimals	0—3	1	1			55
9.35	Interlock update	0 - 1	1	1		Update moment true when run state: 0 = update after the autochange interval or stop state. 1 = update immediately	56

Note!  = Parameter value can be changed only when the frequency converter is stopped.

Table 6-1 Special parameters, Groups 2 - 9.

Group 10, Fieldbus parameters

Code	Parameter	Range	Step	Default	Custom	Description	Page
10.1	Fieldbus control select	0 - 1	1	0		0 = control via I/O terminal 1 = control via fieldbus board	56
10.2	Modbus slave address	1 - 247	1	1			56
10.3	Baud rate	1 - 7	1	6		1 = 300 baud 2 = 600 baud 3 = 1200 baud 4 = 2400 baud 5 = 4800 baud 6 = 9600 baud 7 = 19200 baud	56
10.4	Modbus parity type	0 - 2	1	1		0 = None 1 = Even 2 = Odd	56
10.5	Modbus time-out	0-3600 s	1s	0s		0 = No time-out	56
10.6	Profibus slave address	2 - 126	1	2			57
10.7	Profibus baud rate	1 - 10	1	10		1 = 9.6 kbaud 2 = 19.2 kbaud 3 = 93.75 kbaud 4 = 187.5 kbaud 5 = 500 kbaud 6 = 1.5 Mbaud 7 = 3 Mbaud 8 = 6 Mbaud 9 = 10 AUTO	57
10.8	Profibus PPO type	1 - 4	1	1		1 = PPO1 2 = PPO2 3 = PPO3 4 = PPO4	57
10.9	Profibus process data1	0 - 99	1	1			57
10.10	Profibus process data2	0 - 99	1	2			57
10.11	Profibus process data3	0 - 99	1	3			57
10.12	Profibus process data4	0 - 99	1	99			57
10.13	LonWorks service button	0 - 1	1	0			57

Table 6-2 Fieldbus parameters, Group 10.

6.2 Description of Groups 2—9 parameters

2.1 DIA2 function

- 1: External fault, closing contact = Fault is shown and motor is stopped when the input is active
- 2: External fault, opening contact = Fault is shown and motor is stopped when the input is not active
- 3: Run enable contact open = Start of the motor disabled
contact closed = Start of the motor enabled
- 4: Acc. / Dec time select. contact open = Acceleration/Deceleration time 1 selected
contact closed = Acceleration/Deceleration time 2 selected
- 5: Reverse contact open = Forward
contact closed = Reverse
||| If two or more inputs are progr. to reverse then if one of them is active the direction is reverse
- 6: Jogging freq. contact closed = Jogging frequency selected for freq. refer.
- 7: Fault reset contact closed = Resets all faults
- 8: Acc./Dec. operation prohibited contact closed = Stops acceleration and deceleration until the contact is opened
- 9: DC-braking command contact closed = In the stop mode, the DC-braking operates until the contact is opened, see figure 6-1. Dc-brake current is set with parameter 4. 8.
- 10: Motor pot. UP contact closed = Reference increases until the contact is opened
- 11: Interlock inp., autochange 1 contact closed = Interlock of autochange drive 1 is active

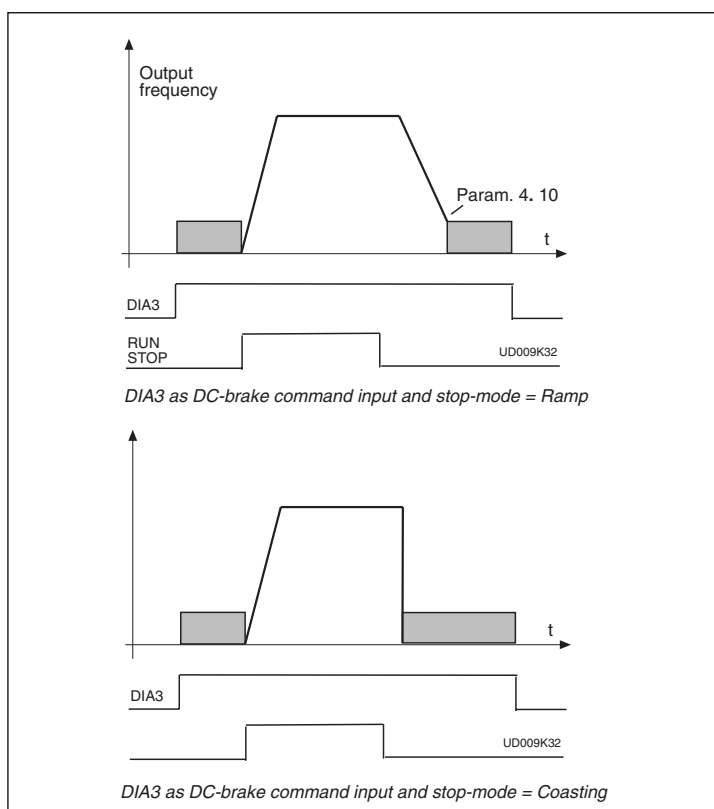

Figure 6-1 DIA3 as DC-brake command input:
 a) Stop-mode = ramp,
 b) Stop-mode = coasting

2. 2 DIA3 function

Selections are the same as in 2. 1 except :

10: Motor pot. contact closed = Reference decreases until the contact is
DOWN opened

2. 3 U_{in} signal range

0 = Signal range 0—10 V

1 = Custom setting range from custom minimum (par. 2. 4) to custom maximum (par. 2. 5)

2 = Signal range 2—10 V

2. 4 U_{in} custom setting minimum/maximum

2. 5 With these parameters you can set U_{in} for any input signal span of 0—10 V.

Minimum setting: Set the U_{in} signal to its minimum level, select parameter 2. 4, press the Enter button

Maximum setting: Set the U_{in} signal to its maximum level, select parameter 2. 5, press the Enter button

Note! The parameter values can only be set with this procedure (not with arrow up/arrow down buttons)

2. 6 U_{in} signal inversion

Parameter 2. 6 = 1, inversion of analogue U_{in} signal.

2. 7 U_{in} signal filter time

Filters out disturbances from the incoming analogue U_{in} signal.

Long filtering time makes regulation response slower.

See figure 6-2.

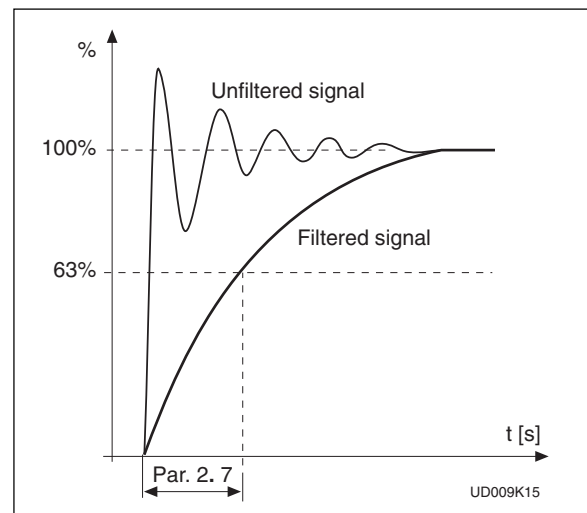

Figure 6-2 U_{in} signal filtering

2. 8 Analogue input I_{in} signal range

0 = 0—20 mA

1 = 4—20 mA

2 = Custom signal span

2. 9 Analogue input I_{in} custom setting

2. 10 minimum/maximum

With these parameters you can scale the input current signal (I_{in}) signal range between 0 and 20 mA. See par. 2. 4 and 2. 5.

2.11 Analogue input I_{in} inversion

Parameter 2.11 = 1, inversion of I_{in} input.

2.12 Analogue input I_{in} filter time

Filters out disturbances from the incoming analogue I_{in} signal. Long filtering time makes regulation response slower. See figure 6-3.

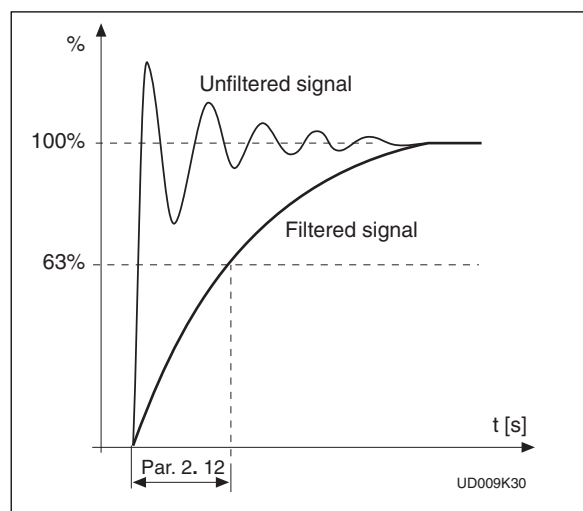

Figure 6-3 Analogue input I_{in} filter time

2.13 DIA5 function

- | | | |
|----------------------|-----------------|---|
| 1: External fault, | closing contact | = Fault is shown and motor is stopped when the input is active |
| 2: External fault, | opening contact | = Fault is shown and motor is stopped when the input is not active |
| 3: Run enable | contact open | = Start of the motor disabled |
| | contact closed | = Start of the motor enabled |
| 4: Acc. / Dec | contact open | = Acceleration/Deceleration time 1 selected |
| time select. | contact closed | = Acceleration/Deceleration time 2 selected |
| 5: Reverse | contact open | = Forward |
| | contact closed | = Reverse |
| | | If two or more inputs are programmed to reverse then if one of them is active the direction is reverse |
| 6: Jogging freq. | contact closed | = Jogging frequency selected for freq. refer. |
| 7: Fault reset | contact closed | = Resets all faults |
| 8: Acc./Dec. | contact closed | = Stops acceleration and deceleration until the contact is opened |
| operation prohibited | | |
| 9: DC-braking | contact closed | = In the stop mode, the DC-braking operates until the contact is opened, see figure 6-1. DC-brake current is set with parameter 4. 8. |
| command | | |
| 10: PI-contr. ref. | contact closed | = reference 2 (selected with par. 2.29) is active |
| selection | | |
| 11: Interlock inp. | contact closed | = Interlock of autochange drive 3 is active |
| autochange 3 | | |

2.14 Motor potentiometer ramp time

Defines how fast the electronic motor potentiometer value changes.

2. 15 PI-controller reference signal (place A)

- 0 Analogue voltage reference from terminals 2—3, e.g. a potentiometer
- 1 Analogue current reference from terminals 4—5, e.g. a transducer.
- 2 Panel reference is the reference set from the Reference Page (REF).
Reference r2 is the PI-controller reference, see chapter 6.
- 3 Reference value is changed with digital input signals DIA2 and DIA3.
 - switch in DIA2 closed = frequency reference increases
 - switch in DIA3 closed = frequency reference decreasesSpeed of the reference change can be set with the parameter 2. 3.
- 4 Same as setting 3 but the reference value is set to the minimum frequency (par. 1. 1) each time the frequency converter is stopped. When value of the parameter 1. 5 is set to 3 or 4, value of the parameter 2.1 is automatically set to 4 and value of the parameter 2. 2 is automatically set to 10.
- 5 Analogue voltage signal from the terminals 202—203 of the I/O-expander
- 6 Analogue signal from the terminals 204—205 of the I/O-expander
 - current signal, Vacon CX 100 OPT
 - voltage signal, Vacon CX 102 OPT
- 7 Fieldbus signal

2. 16 PI-controller actual value selection

- 0 Actual value 1
- 1 Sum of Actual value 1 and Actual value 2
- 2 Difference of Actual value 1 and Actual value 2
- 3 Multiplication of Actual value 1 and Actual value 2
- 4 Minor of signals Actual value 1 and Actual value 2 is active actual value
- 5 Major of signals Actual value 1 and Actual value 2 is active actual value
- 6 Mean value of Actual value 1 and Actual value 2 signals
- 7 Sum of square roots from Actual value 1 and Actual value 2

2. 17 Actual value 1
2. 18 Actual value 2

- 0 No signal
- 1 Analogue voltage reference from terminals 2—3
- 2 Analogue current reference from terminals 4—5
- 3 Analogue voltage signal from the terminals 202—203 of the I/O-expander
- 4 Analogue signal from the terminals 204—205 of the I/O-expander
 - current signal, Vacon CX 100 OPT
 - voltage signal, Vacon CX 102 OPT
- 5 Fieldbus signal

2. 19 Actual value 1 minimum scale

Sets the minimum scaling point for Actual value 1. See figure 6-4.

2. 20 Actual value 1 maximum scale

Sets the maximum scaling point for Actual value 1. See figure 6-4.

2. 21 Actual value 2 minimum scale

Sets the minimum scaling point for Actual value 2. See figure 6-4

2. 22 Actual value 2 maximum scale

Sets the maximum scaling point for Actual value 2. See figure 6-4

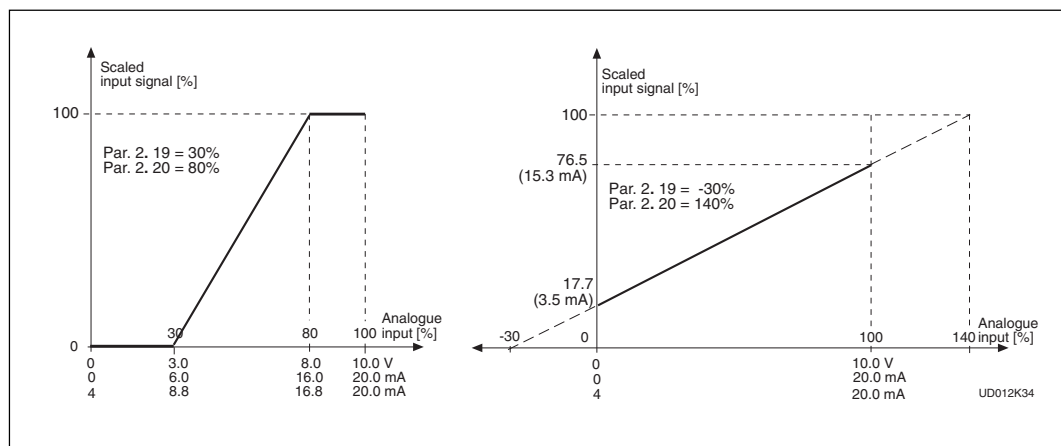

2. 23 Error value inversion

This parameter allows you to invert the error value of the PI-controller (and thus the operation of the PI-controller).

Figure 6-4 Examples about the scaling of actual value signal.

2. 24 PI-controller minimum limit

2. 25 PI-controller maximum limit

These parameters set the minimum and maximum values of the PI-controller output. Parameter value limits: par 1.1 < par. 2. 24 < par. 2. 25.

2. 26 Direct frequency reference, Place B

- 0 Analogue voltage reference from terminals 2—3, e.g. a potentiometer
- 1 Analogue current reference from terminals 4—5, e.g. a transducer.
- 2 Panel reference is the reference set from the Reference Page (REF), Reference r1 is the Place B reference, see chapter 6.
- 3 Reference value is changed with digital input signals DIA2 and DIA3.
 - switch in DIA2 closed = frequency reference increases
 - switch in DIA3 closed = frequency reference decreases
 Speed of the reference change can be set with the parameter 2. 3.
- 4 Same as setting 3 but the reference value is set to the minimum frequency (par. 1. 1) each time the frequency converter is stopped. When value of the parameter 1. 5 is set to 3 or 4, value of the parameter 2. 1 is automatically set to 4 and value of the parameter 2. 2 is automatically set to 10.

2. 27 Place B reference scaling, minimum value/maximum value

Setting limits: 0 < par. 2. 27 < par. 2. 28 < par. 1. 2.

If par. 2. 28 = 0 scaling is set off. See figures 6-5 and 6-6.

(In the figures voltage input U_{in} with signal range 0—10 V selected for source B reference)

See Figure 6-5 Reference scaling and Figure 6-6 Reference scaling, par. 2.15 = 0. (next page).

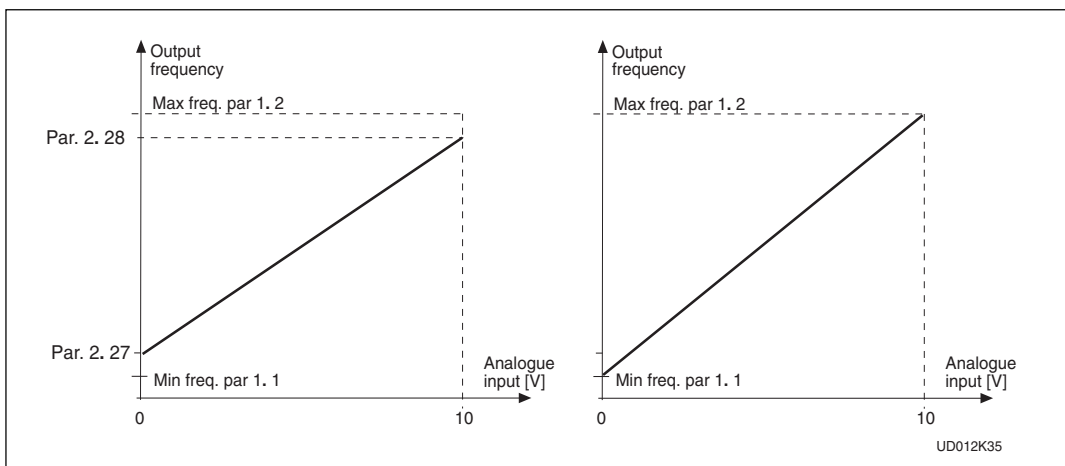

2. 29 PI-controller reference signal 2 (place A)

- 0 Analogue voltage reference from terminals 2—3, e.g. a potentiometer
- 1 Analogue current reference from terminals 4—5, e.g. a transducer.
- 2 Panel reference is the reference set from the Reference Page (REF). Reference r2 is the PI-controller reference, see chapter 6.
- 3 Reference value is changed with digital input signals DIA2 and DIA3.
 - switch in DIA2 closed = frequency reference increases
 - switch in DIA3 closed = frequency reference decreases
 Speed of the reference change can be set with the parameter 2. 3.
- 4 Same as setting 3 but the reference value is set to the minimum frequency (par. 1. 1) each time the frequency converter is stopped. When value of the parameter 1. 5 is set to 3 or 4, value of the parameter 2.1 is automatically set to 4 and value of the parameter 2. 2 is automatically set to 10.
- 5 Analogue voltage signal from the terminals 202—203 of the I/O-expander
- 6 Analogue signal from the terminals 204—205 of the I/O-expander
 - current signal, Vacon CX 100 OPT
 - voltage signal, Vacon CX 102 OPT
- 7 Panel reference r3, can be set on the Reference Page (REF) of the panel.

2. 30 Ain1 signal inversion (I/O-expander)

Parameter 2. 30 = 0, no inversion

2. 31 Ain1 signal filter time

Filters out disturbances from the incoming analogue Ain1 signal. Long filtering time makes regulation response slower.

2. 32 Ain2 input (I/O-expander) signal range

0 = 0—20 mA

1 = 4—20 mA

2 = 0-10 V (must be used with 102 OPT)

2. 33 Ain2 signal inversion (I/O-expander)

Parameter 2. 33 = 0, no inversion

2. 34 Ain2 signal filter time

Filters out disturbances from the incoming analogue Ain2 signal. Long filtering time makes regulation response slower.

3.1 Analogue output function

See table on page 13.

3.2 Analogue output filter time

Filters the analogue output signal.
See figure 6-7.

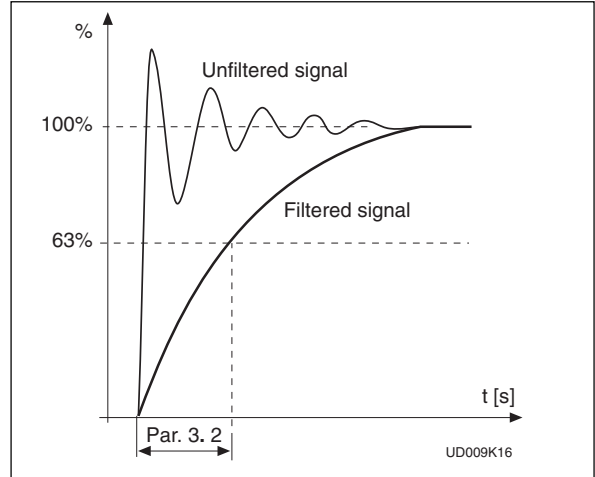

Figure 6-7 Analogue output filtering.

3.3 Analogue output invert

Inverts analogue output signal:
max. output signal = minimum set value
min. output signal = maximum set value

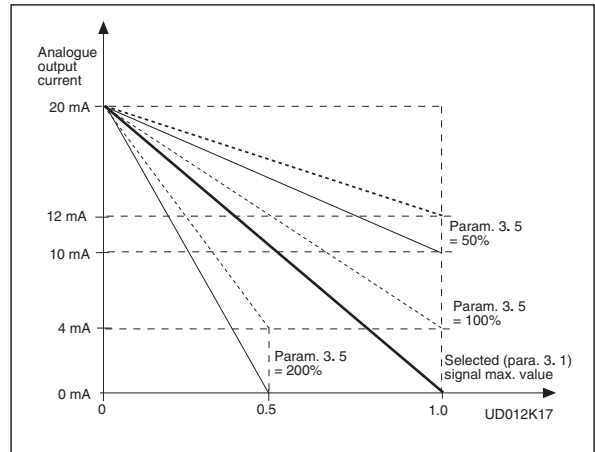

Figure 6-8 Analogue output invert.

3.4 Analogue output minimum

Defines the signal minimum to be either 0 mA or 4 mA (living zero). See figure 6-9.

3.5 Analogue output scale

Scaling factor for analogue output.
See figure 6-9.

Signal	Max. value of the signal
Output freq.	Max. frequency (p. 1. 2)
Motor speed	Max. speed ($n_n \times f_{max} / f_n$)
Output current	$2 \times I_{nCX}$
Motor torque	$2 \times T_{nCX}$
Motor power	$2 \times P_{nCX}$
Motor voltage	$100\% \times U_{nmotor}$
DC-link volt.	1000 V
PI-ref. value	100% x ref. value max.
PI-act. value1	100% x act. value max.
PI-act. value2	100% x act. value max.
PI-error value	100% x error value max.
PI-output	100% x output max.

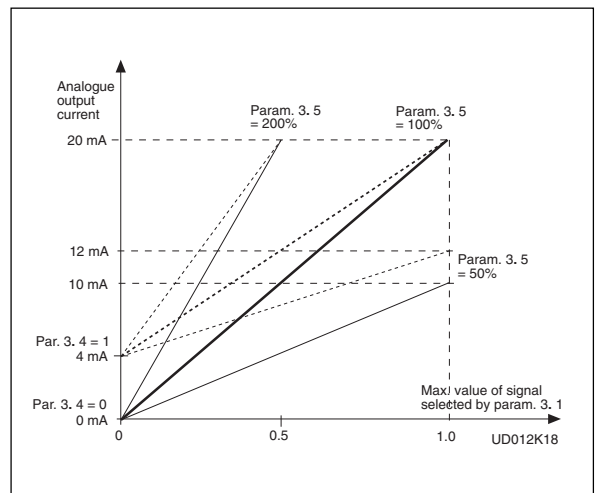

Figure 6-9 Analogue output

scale.

3.6 Digital output function

Setting value	Signal content
0 = Not used	Out of operation <u>Digital output DO1 sinks current and programmable relay (RO1, RO2) is activated when:</u>
1 = Ready	The frequency converter is ready to operate
2 = Run	The frequency converter operates (motor is running)
3 = Fault	A fault trip has occurred
4 = Fault inverted	A fault trip <u>has not</u> occurred
5 = Vacon overheat warning	The heat-sink temperature exceeds +70°C
6 = External fault or warning	Fault or warning depending on parameter 7. 2
7 = Reference fault or warning	Fault or warning depending on parameter 7. 1 - if analogue reference is 4—20 mA and signal is <4mA
8 = Warning	Always if a warning exists
9 = Reversed	The reverse command has been selected
10= Multi-step or jogging speed	Multi-step or jog. speed has been selected with digital input
11= At speed	The output frequency has reached the set reference
12= Motor regulator activated	Overvoltage or overcurrent regulator was activated
13= Output frequency supervision 1	The output frequency goes beyond the set supervision Low limit/ High limit (par. 3. 9 and par. 3. 10)
14= Output frequency supervision 2	The output frequency goes beyond the set supervision Low limit/ High limit (par. 3. 11 and par. 3. 12)
15= Torque limit supervision	The motor torque goes beyond the set supervision Low limit/ High limit (par. 3. 13 and par. 3. 14)
16= Active reference limit supervision	Active reference goes beyond the set supervision Low limit/ High limit (par. 3. 15 and par. 3. 16)
17= External brake control	External brake ON/OFF control with programmable delay (par 3. 17 and 3. 18)
18= Control from I/O terminals	External control mode selected with pr. push-button #2
19= Frequency converter temperature limit supervision	Temperature on frequency converter goes beyond set supervision limits (par. 3. 19 and 3. 20)
20= Unrequested rotation direction	Rotation direction of the motor shaft is different from the requested one
21 = External brake control inverted	External brake ON/OFF control (par. 3.17 and 3.18), output active when brake control is ON
22= Analog input limit supervision	The level of selected analog input goes beyond the set supervision low / high limit (par. 3. 29 and par. 3. 30)
23—26 = Not in use	
27 = Autochange 3 control	Control signal for drive 3 in autochange system
28 = Auxiliary drive 1 start	Starts and stops auxiliary drive 1
29 = Auxiliary drive 2 start	Starts and stops auxiliary drive 2
30 = Auxiliary drive 3 start	Starts and stops auxiliary drive 3

Table 6-3a Output signals via DO1

3.7 Relay output 1 content

Setting value	Signal content
0-22 = Same as parameter 3.6	
23—25 = Not in use	
26 = Autochange 1 control	Control signal for drive 1 in autochange system
27 = Autochange 4 control	Control signal for drive 1 in autochange system with I/O-expander option
28 = Auxiliary drive 1 start	Starts and stops auxiliary drive 1
29 = Auxiliary drive 2 start	Starts and stops auxiliary drive 2
30 = Auxiliary drive 3 start	Starts and stops auxiliary drive 3

Table 6-3b Output signals via RO1

3. 8 Relay output 2 content

Setting value	Signal explanation
0-22 = Same as parameter 3.6 23—25 = Not in use 26 = Autochange 2 control 27 = Autochange 5 control	Control signal for drive 2 in autochange system Control signal for drive 5 in autochange system with I/O-expander option
28 = Auxiliary drive 1 start 29 = Auxiliary drive 2 start 30 = Auxiliary drive 3 start	Starts and stops auxiliary drive 1 Starts and stops auxiliary drive 2 Starts and stops auxiliary drive 3

Table 6-3c Output signals via RO2

3. 9 Output frequency limit 1, supervision function
3. 11 Output frequency limit 2, supervision function

- 0 = No supervision
- 1 = Low limit supervision
- 2 = High limit supervision

If the output frequency goes under/over the set limit (3. 10, 3. 12) this function generates a warning message via the digital output DO1 or via the relay output RO1 or RO2 depending on the settings of the parameters 3. 6—3. 8.

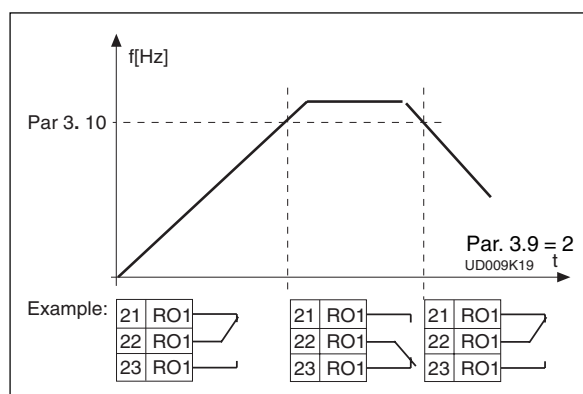

Figure 6-10 Output frequency supervision.

3. 10 Output frequency limit 1, supervision value
3. 12 Output frequency limit 2, supervision value

The frequency value to be supervised by the parameter 3. 9 (3. 11). See figure 6-10.

3. 13 Torque limit, supervision function

- 0 = No supervision
- 1 = Low limit supervision
- 2 = High limit supervision

If the calculated torque value goes under/over the set limit (3. 14) this function generates a warning message via the digital output DO1 or via a relay output RO1 or RO2 depending on the settings of the parameters 3. 6—3. 8.

3. 14 Torque limit, supervision value

The calculated torque value to be supervised by the parameter 3. 13.

3. 15 Active reference limit, supervision function

- 0 = No supervision
- 1 = Low limit supervision
- 2 = High limit supervision

If the reference value goes under/over the set limit (3. 16) this function generates a warning message via the digital output DO1 or via a relay output RO1 or RO2 depending on the settings of the parameters 3. 6—3. 8. The supervised reference is the current active reference. It can be source A or B reference depending on DIB6 input or panel reference if the panel is the active control source.

3. 16 Active reference limit, supervision value

The frequency value to be supervised by the parameter 3. 15.

3. 17 External brake-off delay

3. 18 External brake-on delay

With these parameters the timing of external brake can be linked to the Start and Stop control signals, see figure 6-11.

The brake control signal can be programmed via the digital output DO1 or via one of relay outputs RO1 and RO2, see parameters 3. 6—3. 8.

The temperature value to be supervised by the parameter 3. 20.

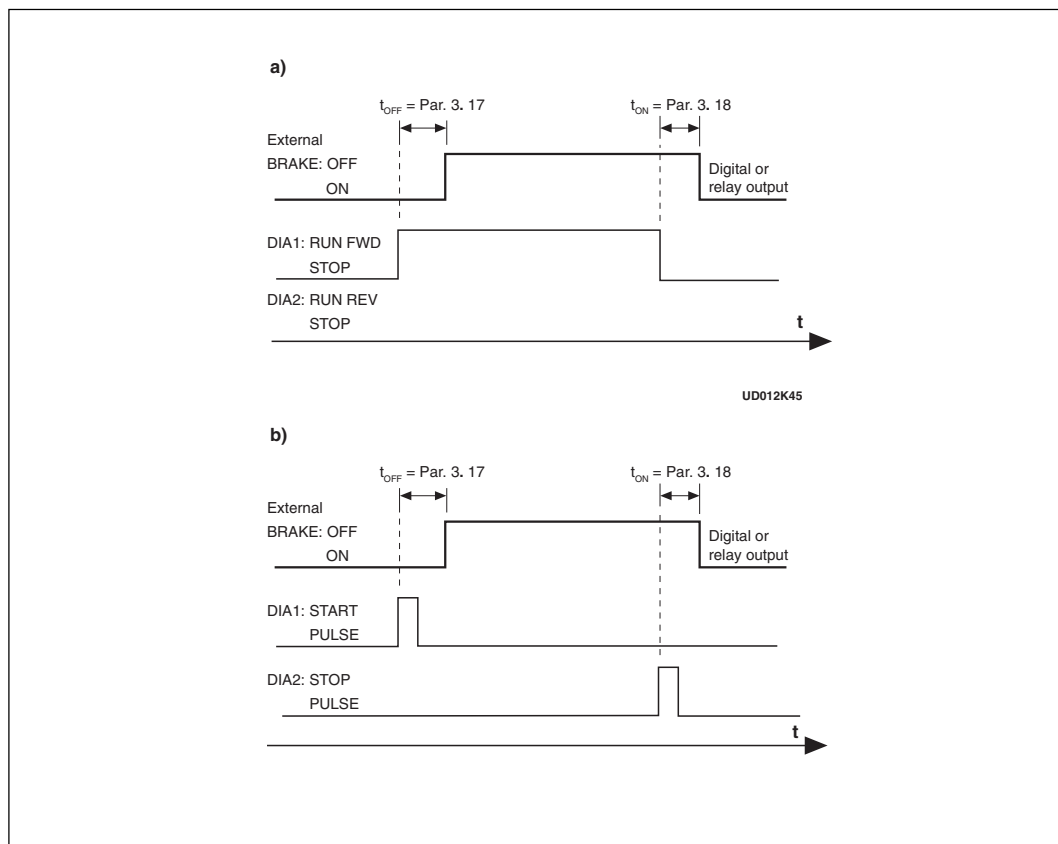

Figure 6-11 External brake control:
 a) Start/Stop logic selection par. 2. 1 = 0, 1 or 2
 b) Start/Stop logic selection par. 2. 1 = 3.

3. 19 Frequency converter temperature limit supervision function

- 0 = No supervision
- 1 = Low limit supervision
- 2 = High limit supervision

If the temperature of the frequency converter goes under/over the set limit (3. 20) this function generates a warning message via the digital output DO1 or via a relay output RO1 or RO2 depending on the settings of the parameters 3. 6—3. 8.

3. 20 Frequency converter temperature limit value

The temperature value to be supervised by the parameter 3. 19.

3. 26 Analogue output offset

3. 27 I/O-expander analogue output offset

With these parameters can be set the offsets of the basic control board and I/O-expander analogue outputs. See figure 6-12.

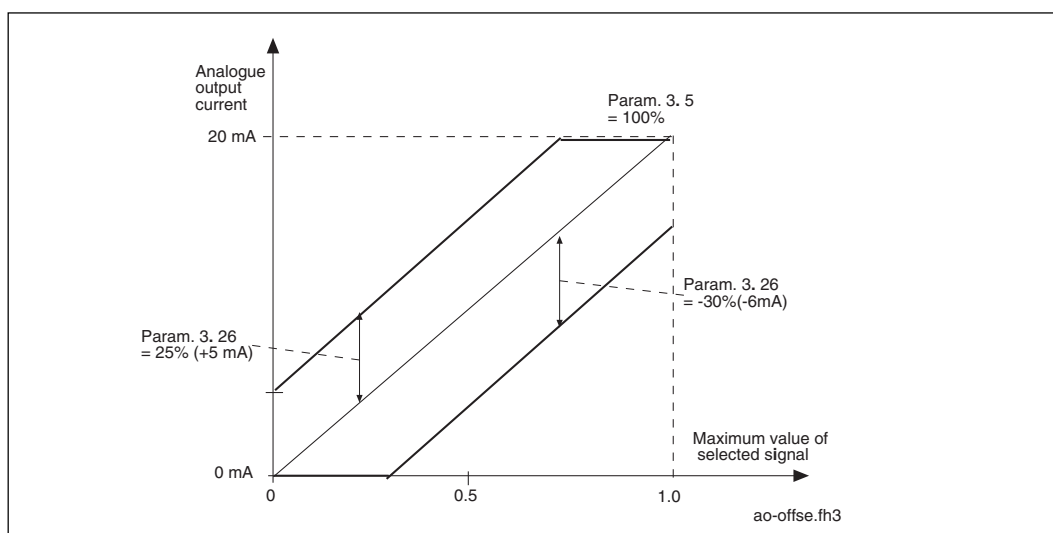

Figure 6-12 Analogue output offset

3. 28 Analogue input supervision, input signal selection

- 0 Analogue voltage signal from terminals 2—3
- 1 Analogue current signal from terminals 4—5
- 2 Analogue voltage signal from terminals 202—203 of the I/O-expander
- 3 Analogue signal from the terminals 204—205 of the I/O-expander
 - current signal, Vacon CX 100 OPT
 - voltage signal, Vacon CX 102 OPT

3. 29 Analogue input supervision function

- 0 = No supervision
- 1 = Low limit supervision
- 2 = High limit supervision

If the value of the selected analogue input (par. 3.28) goes under/over the set limit (3. 30) this function generates a warning message via the digital output DO1 or via a relay output RO1 or RO2 depending on the settings of the parameters 3. 6—3. 8.

3. 30 Analogue input supervision limit value

The value of the analogue input to be supervised by the parameter 3. 29.

4.1 Acc/Dec ramp 1 shape**4.2 Acc/Dec ramp 2 shape**

The start and end of the acceleration and deceleration ramps can be smoothed with these parameters. Setting value 0 gives a linear ramp shape which causes acceleration and deceleration to react immediately to the changes in the reference signal with the time constant set by the parameter 1.3 and 1.4 (4.3 and 4.4).

Setting value 0.1—10 seconds for 4.1 (4.2) causes linear acceleration/deceleration to adopt an S-shape. Parameters 1.3 and 1.4 (4.3 and 4.4) determine the time constant of acceleration/deceleration in the middle of the curve.

See figure 6-13.

4.3 Acceleration time 2**4.4 Deceleration time 2**

These values correspond to the time required for the output frequency to accelerate from the set minimum frequency (par. 1.1) to the set maximum frequency (par. 1.2). These times give the possibility to set two different acceleration/deceleration time sets for one application. The active set can be selected with the programmable signal DIA3 of this application, see parameter 2.2. Acceleration/deceleration times can be reduced with an external free analogue input signal, see parameters 2.18 and 2.19.

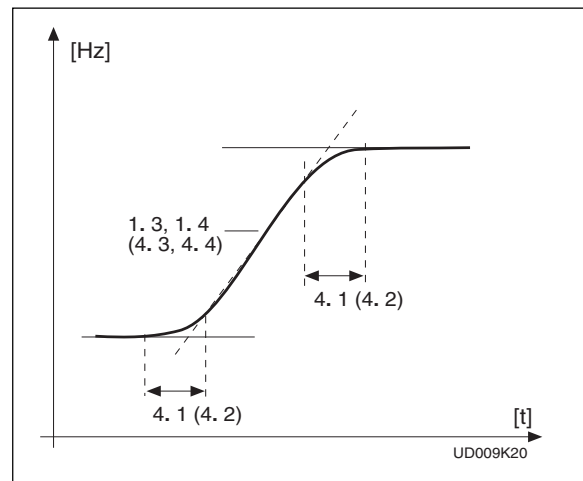

Figure 6-13 S-shaped acceleration / deceleration.

4.5 Brake chopper

0 = No brake chopper

1 = Brake chopper and brake resistor installed

2 = External brake chopper

When the frequency converter is decelerating the motor, the inertia from the motor and the load is fed into the external brake resistor. This enables the frequency converter to decelerate the load with the torque equal to that of acceleration, if the brake resistor is selected correctly. See separate Brake resistor installation manual.

4.6 Start function

Ramp:

- 0** The frequency converter starts from 0 Hz and accelerates to the set reference frequency within the set acceleration time. (Load inertia or starting friction may cause prolonged acceleration times).

Flying start:

- 1** The frequency converter is able to start into running motor by applying a small torque to motor and searching for frequency corresponding to the speed the motor is running at. Searching starts from the maximum frequency towards the actual frequency until the correct value is detected. Thereafter the output frequency will be accelerated/decelerated to the set reference value according to the set acceleration/deceleration parameters.

Use this mode if the motor may be coasting when the start command is given. With the flying start it is possible to ride through short mains voltage interruptions.

4.7 Stop function

Coasting:

- 0** The motor coasts to a halt without any control from the frequency converter, after the Stop command.

Ramp:

- 1** After the Stop command, the speed of the motor is decelerated according to the set deceleration parameters. If the regenerated energy is high it may be necessary to use an external braking resistor for faster deceleration.

4.8 DC braking current

Defines the current injected into the motor during the DC braking.

4.9 DC braking time at stop

Defines if braking is ON or OFF and braking time of the DC-brake when the motor is stopping. The function of the DC-brake depends on the stop function, parameter 4.7. See figure 6-14.

- 0 DC-brake is not used
- >0 DC-brake is in use and its function depends on the Stop function, (param. 4.7), and the time depends on the value of parameter 4.9:

Stop-function = 0 (coasting):

After the stop command, the motor coasts to a stop without any control from the frequency converter.

With DC-injection, the motor can be electrically stopped in the shortest possible time, without using an optional external braking resistor.

The braking time is scaled according to the frequency when the DC-braking starts. If the frequency is \geq nominal frequency of the motor (par. 1.11), the setting value of parameter 4.9 determines the braking time. When the frequency is $\leq 10\%$ of the nominal, the braking time is 10% of the set value of parameter 4.9.

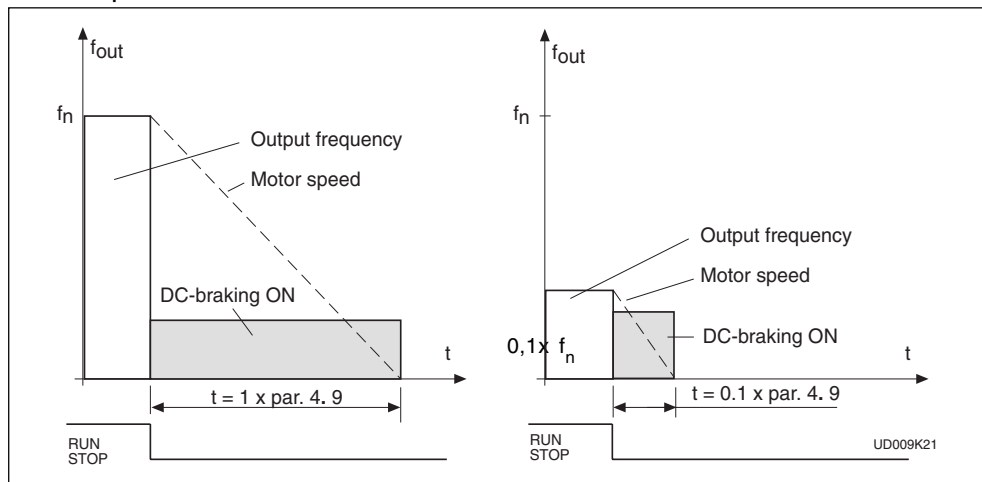

Figure 6-14 DC-braking time when par. 4.7 = 0.

Stop-function = 1 (ramp):

After the Stop command, the speed of the motor is reduced according to the set deceleration parameters, as fast as possible, to a speed defined with the parameter 4.10, where the DC-braking starts. The braking time is defined with parameter 4.9. If high inertia exists, it is recommended to use an external braking resistor for faster deceleration. See figure 6-15.

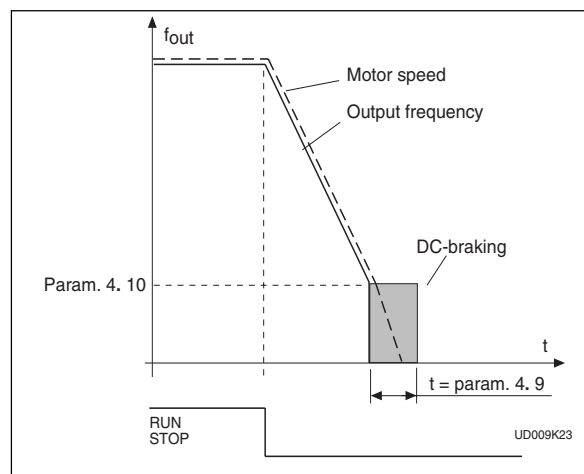

Figure 6-15 DC-braking time when par. 4.7 = 1.

4. 10 Execute frequency of DC-brake during ramp Stop

See figure 6-15.

4. 11 DC-brake time at start

- 0** DC-brake is not used
- >0** DC-brake is activated when the start command is given and this parameter defines the time before the brake is released. After the brake is released, the output frequency increases according to the set start function parameter 4.6 and acceleration parameters (1. 3, 4. 1 or 4.2, 4.3), see figure 6-16.

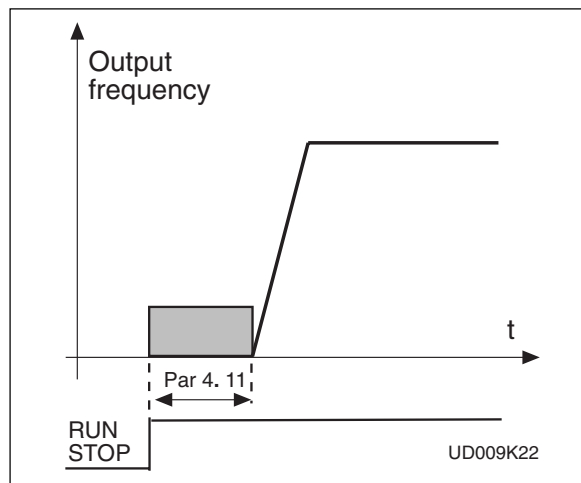

Figure 6-16 DC-braking time at start

4. 12 Jogging speed reference

Parameter value defines the jogging speed selected with the digital input.

- 5. 1 Prohibit frequency area,**
- 5. 2 Low limit/High limit**
- 5. 3**
- 5. 4**
- 5. 5**
- 5. 6**

In some systems it may be necessary to avoid certain frequencies because of mechanical resonance problems. With these parameters it is possible to set limits for three "skip frequency" regions.

Figure 6-17 Example of prohibit frequency area setting.

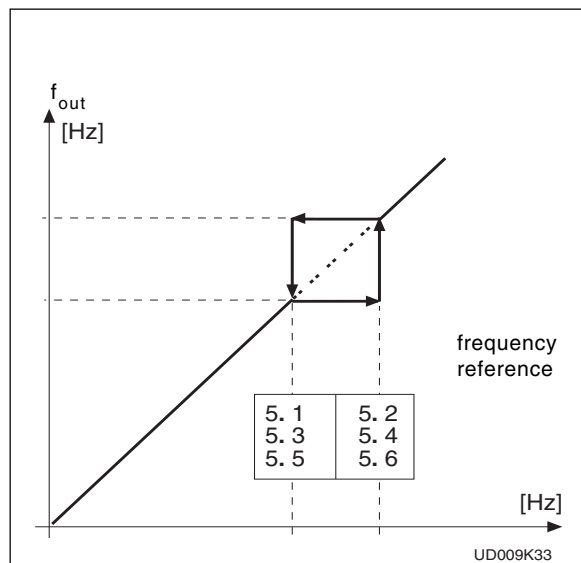

6. 1 Motor control mode

0 = Frequency control:

The I/O terminal and panel references are frequency references and the frequency converter controls the output frequency (output freq. resolution 0,01 Hz)

1 = Speed control:

The I/O terminal and panel references are speed references and the frequency converter controls the motor speed (regulation accuracy $\pm 0,5\%$).

6.2 Switching frequency

Motor noise can be minimized by using high switching frequency. Increasing the frequency reduces the capacity of the frequency converter. Before changing the frequency from the factory default 10 kHz (3.6 kHz from 30 kW upwards), check the allowed capacity from the curves in the figure 5.2-3 of the User's Manual.

6.3 Field weakening point

6.4 Voltage at the field weakening point

Field weakening point is the output frequency where the output voltage reaches the set maximum value (par. 6.4). Above that frequency the output voltage remains at the set maximum value.

Below that frequency output voltage depends on the setting of the U/f curve parameters 1.8, 1.9, 6.5, 6.6 and 6.7. See figure 6-18.

When the parameters 1.10 and 1.11, nominal voltage and nominal frequency of the motor, are set, also parameters 6.3 and 6.4 are set automatically to the corresponding values. If different values for the field weakening point and the maximum output voltage are required, change these parameters after setting the parameters 1.10 and 1.11.

6.5 U/f curve, middle point frequency

If the programmable U/f curve has been selected with the parameter 1.8 this parameter defines the middle point frequency of the curve. See figure 6-18.

6.6 U/f curve, middle point voltage

If the programmable U/f curve has been selected with the parameter 1.8 this parameter defines the middle point voltage (% from motor nom. voltage) of the curve. See figure 6-18.

6.7 Output voltage at zero frequency

If the programmable U/f curve has been selected with the parameter 1.8 this parameter defines the zero frequency voltage of the curve. See figure 6-18.

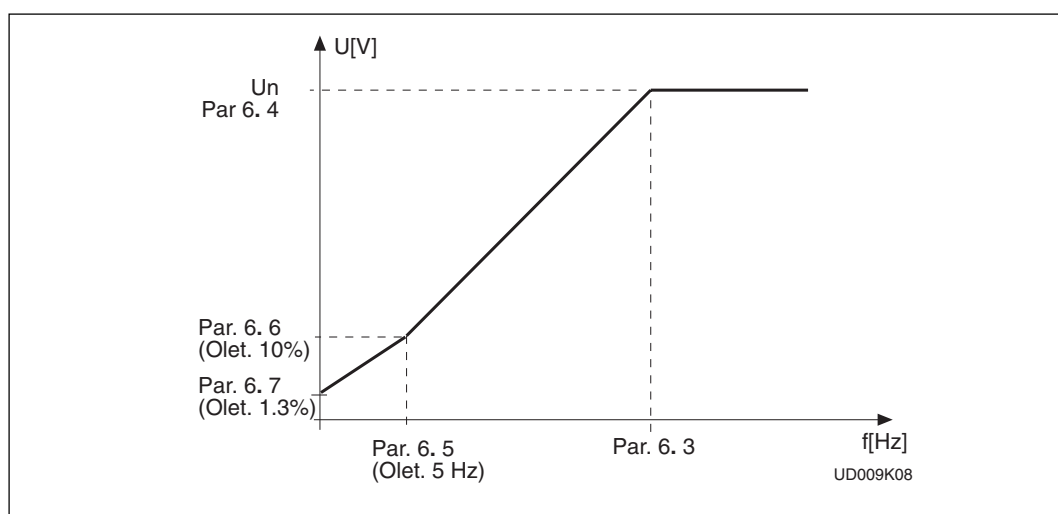

Figure 6-18 Programmable U/f curve.

6.8 Overvoltage controller**6.9 Undervoltage controller**

These parameters allow the over/undervoltage controllers to be switched out of operation. This may be useful, for example, if the mains supply voltage varies more than -15%—+10% and the application will not tolerate this over-/undervoltage, the regulator controls output frequency according to the supply fluctuations.

Over/undervoltage trips may occur when controllers are switched out of operation.

7.1 Response to the reference fault

0 = No response

1 = Warning

2 = Fault, stop mode after fault according to parameter 4.7

3 = Fault, stop mode after fault always by coasting

A warning or a fault action and message is generated if 4—20 mA reference signal is used and the signal falls below 4 mA. The information can also be programmed via digital output DO1 and via relay outputs RO1 and RO2.

7.2 Response to external fault

0 = No response

1 = Warning

2 = Fault, stop mode after fault according to parameter 4.7

3 = Fault, stop mode after fault always by coasting

A warning or a fault action and message is generated from the external fault signal in the digital input DIA3. The information can also be programmed into digital output DO1 and into relay outputs RO1 and RO2.

7.3 Phase supervision of the motor

0 = No action

2 = Fault

Phase supervision of the motor ensures that the motor phases have approximately equal current.

7.4 Earth fault protection

0 = No action

2 = Fault message

Earth fault protection ensures that the sum of the motor phase currents is zero.

The overcurrent protection is always working and protects the frequency converter from earth faults with high currents.

Parameters 7.5—7.9 Motor thermal protection**General**

Motor thermal protection is to protect the motor from overheating. Vacon CX/CXL/CXS drive is capable of supplying higher than nominal current to the motor. If the load requires this high current there is a risk that motor will be thermally overloaded. This is true especially at low frequencies. With low frequencies the cooling effect of the motor is reduced and the capacity of the motor is reduced. If the motor is equipped with an external fan the load reduction on low speeds is small.

Motor thermal protection is based on a calculated model and it uses the output current of the drive to determine the load on the motor. When the power is turned on to the drive, the calculated model uses the heatsink temperature to determine the initial thermal stage for the motor. The calculated model assumes that the ambient temperature of the motor is 40°C.

Motor thermal protection can be adjusted by setting the parameters. The thermal current I_T specifies the load current above which the motor is overloaded. This current limit is a function of the output frequency. The curve for I_T is set with parameters 7. 6, 7. 7 and 7. 9 (refer to the figure 5-18). The parameters have their default values set from the motor name plate data.

With the output current at I_T the thermal stage will reach the nominal value (100%). The thermal stage changes by the square of the current. With output current at 75% of I_T the thermal stage will reach 56% level and with output current at 120% from I_T the thermal stage would reach 144% level. The function will trip the device (refer par. 7. 5) if the thermal stage will reach a value of 105%. The speed of change in thermal stage is determined with the time constant parameter 7. 8. The bigger the motor the longer it takes to reach the final temperature.

The thermal stage of the motor can be monitored through the display. Refer to the table for monitoring items. (User's Manual, table 7.3-1).



CAUTION! *The calculated model does not protect the motor if the airflow to the motor is reduced by blocked air intake grill.*

7. 5 Motor thermal protection

Operation:

0 = Not in use

1 = Warning

2 = Trip function

Tripping and warning will display the same message code. If the tripping is selected the drive will stop and activate the fault stage.

Deactivating the protection, setting parameter to 0, will reset the thermal stage of the motor to 0%.

7. 6 Motor thermal protection, break point current

The current can be set between 50.0—150.0% x I_{nMotor}

This parameter sets the value for thermal current at frequencies above the break point on the thermal current curve. Refer to the figure 6.5-18.

The value is set in percentage which refers to the name plate data of the motor, parameter 1. 13, nominal current of the motor, not the drive's nominal output current.

The motor's nominal current is the current which the motor can withstand in direct on-line use without being overheated.

If parameter 1. 13 is adjusted, this parameter is automatically restored to the default value.

Setting this parameter (or parameter 1. 13) does not affect the maximum output current of the drive. Parameter 1. 7 alone determines the maximum output current of the drive.

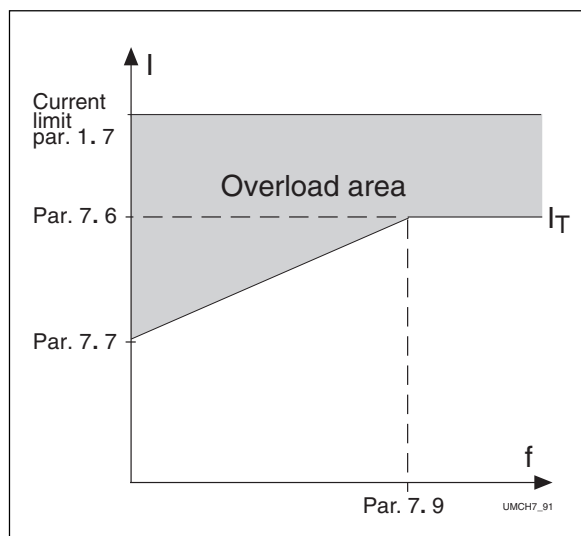

Figure 6-19 Motor thermal current I_T curve.

7.7 Motor thermal protection, zero frequency current

The current can be set between 10.0—150.0% $\times I_{nMotor}$. This parameter sets the value for thermal current at zero frequency. Refer to the figure 5-18.

The default value is set assuming that there is no external fan cooling the motor. If an external fan is used this parameter can be set to 90% (or even higher).

The value is set as a percentage of the motor name plate data, parameter 1.13, motor's nominal current, not the drive's nominal output current. Motor's nominal current is the current which the motor can stand in direct on-line use without being overheated.

If you change the parameter 1.13 this

parameter is automatically restored to the default value.

Setting this parameter (or parameter 1.13) does not affect to the maximum output current of the drive. Parameter 1.7 alone determines the maximum output current of the drive.

7.8 Motor thermal protection, time constant

The time can be set between 0.5—300 minutes. This is the thermal time constant of the motor. The bigger the motor the bigger the time constant. The time constant is the time when the calculated thermal stage has reached 63% of its final value.

The motor thermal time is specific for the motor design and it varies between different motor manufacturers.

The default value for the time constant is calculated on the basis of the motor name plate data given with parameters 1.12 and 1.13. If either of these parameters is set, then this parameter is set to default value.

If the motor's t_6 -time is known (given by the motor manufacturer) the time constant

parameter could be set based on t_6 -time. As a rule of thumb, the motor thermal time constant in minutes equals to $2 \times t_6$ (t_6 in seconds is the time a motor can safely operate at six times the rated current). If the drive is in stop stage the time constant is internally increased to three times the set parameter value. The cooling in the stop stage is based on convection and the time constant is increased.

7.9 Motor thermal protection, break point frequency

The frequency can be set between 10—500 Hz. This is the break point of thermal current curve. With frequencies above this point the thermal capacity of the motor is assumed to be constant. Refer to the figure 6-19.

The default value is based on the motor's name plate data, parameter 1. 11. It is 35 Hz for a 50 Hz motor and 42 Hz for a 60 Hz motor. More generally, it is 70% of the frequency at field weakening point (parameter 6. 3). Changing either parameter 1. 11 or 6. 3 will restore this parameter to its default value.

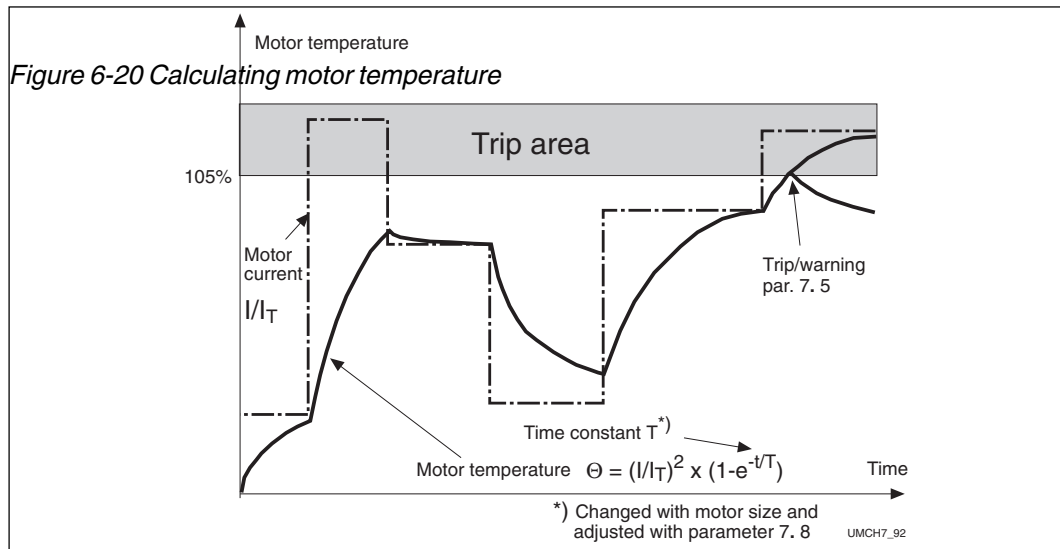

Parameters 7. 10— 7. 13, Stall protection
General

Motor stall protection protects the motor from short time overload situations caused by e.g. a stalled shaft. The reaction time of stall protection can be set shorter than that of motor thermal protection. The stall state is defined with two parameters, 7.11. Stall Current and 7.13. Stall Frequency. If the current is higher than the set limit and output frequency is lower than the set limit the stall state is true. There is actually no real indication of the shaft rotation. Stall protection is a type of overcurrent protection.

7. 10 Stall protection

Operation:

- 0 = Not in use
- 1 = Warning
- 2 = Trip function

Tripping and warning will display the same message code. If the tripping is set on, the drive will stop and activate the fault stage.

Setting the parameter to 0 will deactivate the protection and will reset the stall time counter to zero.

7. 11 Stall current limit

The current can be set between 0.0—200% x I_{nMotor} .

In the stall stage the current has to be above this limit. Refer to the figure 6-21. The value is set as a percentage of the motor's name plate data, parameter 1. 13, motor's nominal current. If parameter 1. 13 is adjusted, this parameter is automatically restored to the default value.

Figure 6-21 Setting the stall characteristics.

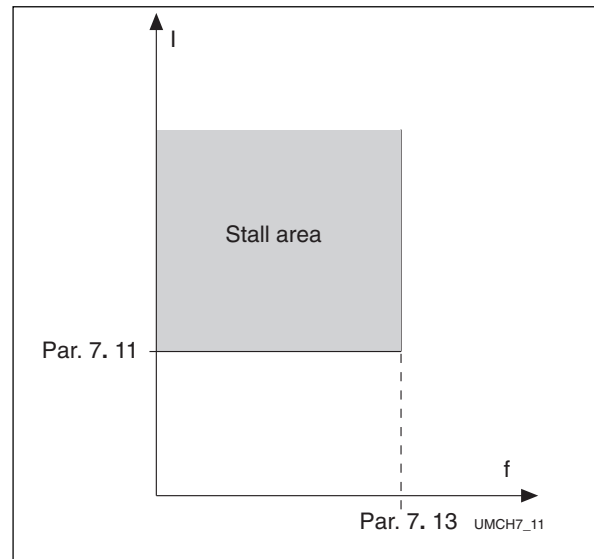

7. 12 Stall time

The time can be set between 2.0—120 s.

This is the maximum allowed time for a stall stage. There is an internal up/down counter to count the stall time. Refer to the figure 6-22.

If the stall time counter value goes above this limit the protection will cause a trip (refer to the parameter 7. 10).

7. 13 Maximum stall frequency

The frequency can be set between 1— f_{max} (par. 1. 2).

In the stall state, the output frequency has to be smaller than this limit. Refer to the figure 6-21.

Figure 6-22 Counting the stall time.

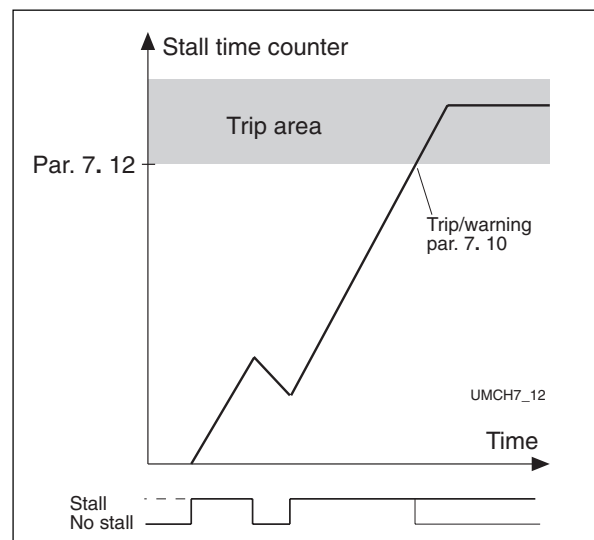

Parameters 7. 14— 7. 17, Underload protection General

The purpose of motor underload protection is to ensure that there is load on the motor whilst the drive is running. If the motor loses its load there might be a problem in the process, e.g. a broken belt or dry pump.

Motor underload protection can be adjusted by setting the underload curve with parameters 7. 15 and 7. 16. The underload curve is a squared curve set between zero frequency and the field weakening point. The protection is not active below

5Hz (the underload counter value is stopped). Refer to the figure 6-23.

The torque values for setting the underload curve are set in percentage which refer to the nominal

torque of the motor. The motor's name plate data, parameter 1. 13, the motor's nominal current and the drive's nominal current I_{CT} are used to find the

scaling ratio for the internal torque value. If other than nominal motor is used with the drive the accuracy of the torque calculation is decreased.

7. 14 Underload protection

Operation:

- 0 = Not in use
- 1 = Warning
- 2 = Fault

Tripping and warning will display the same message code. If tripping is set active the drive will stop and activate the fault stage.

Deactivating the protection, by setting parameter to 0, will reset the underload time counter to zero.

7. 15 Underload protection, field weakening area load

The torque limit can be set between 20.0—150 % $\times T_{nMotor}$.

This parameter gives the value for the minimum allowed torque when the output frequency is above the field weakening point.

Refer to the figure 6-23.

If parameter 1. 13 is adjusted, this parameter is automatically restored to the default value.

Figure 6-23
Setting of minimum load.

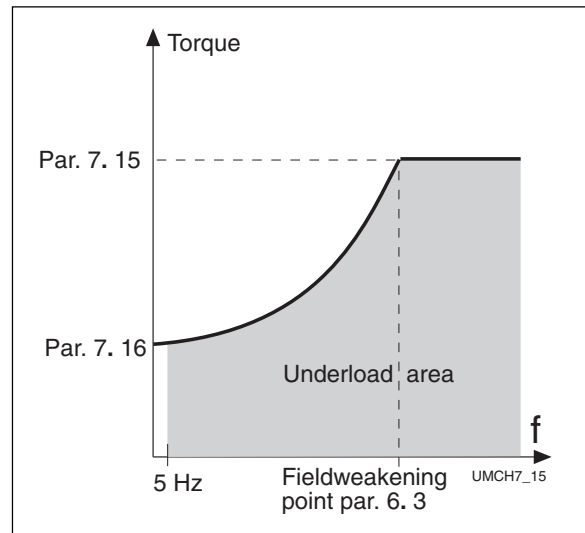

7. 16 Underload protection, zero frequency load

The torque limit can be set between 10.0—150 % $\times T_{nMotor}$.

This parameter gives value for the minimum allowed torque with zero frequency. Refer to the figure 6-23. If parameter 1. 13 is adjusted, this parameter is automatically restored to the default value.

7. 17 Underload time

This time can be set between 2.0—600.0 s.

This is the maximum allowed time for an underload state. There is an internal up/down counter to accumulate the underload time. Refer to the figure 6-24.

If the underload counter value goes above this limit the protection will cause a trip (refer to the parameter 7. 14). If the drive is stopped the underload counter is reseted to zero.

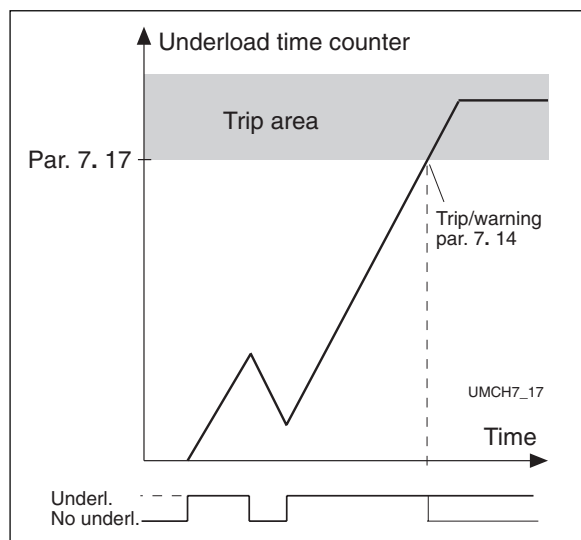

Figure 6-24 Counting the underload time.

7. 18 Phase supervision of the supply voltage

0 = No action
2 = Fault

By setting the parameter value to zero the phase supervision of the supply voltage will not cause tripping.

7. 19 Termistor input of IO-Expander

0 = No action
1 = Warning
2 = Fault

The termistors connected to the termistor input of the I/O-expander board supervise the temperature of the motor. With parameter 7.19 the response of the frequency converter when the termistors indicate about overtemperature can be programmed.

7.20 Fieldbus fault

0 = No action
1 = Warning
2 = Fault

8. 1 Automatic restart: number of tries

8. 2 Automatic restart: trial time

The Automatic restart function restarts the frequency converter after the faults selected with parameters 8. 4—8. 8. The Start function for Automatic restart is selected with parameter 8. 3.

Parameter 8. 1 determines how many automatic restarts can be made during the trial time set by the parameter 8. 2.

The time counting starts from the first autorestart. If the number of restarts does not exceed the value of the parameter 8.1 during the trial time, the counting is cleared after the time is elapsed and next fault starts the counting again. See figure 6-25.

If the automatic restart trial time is 0s, the automatic restart is not used.

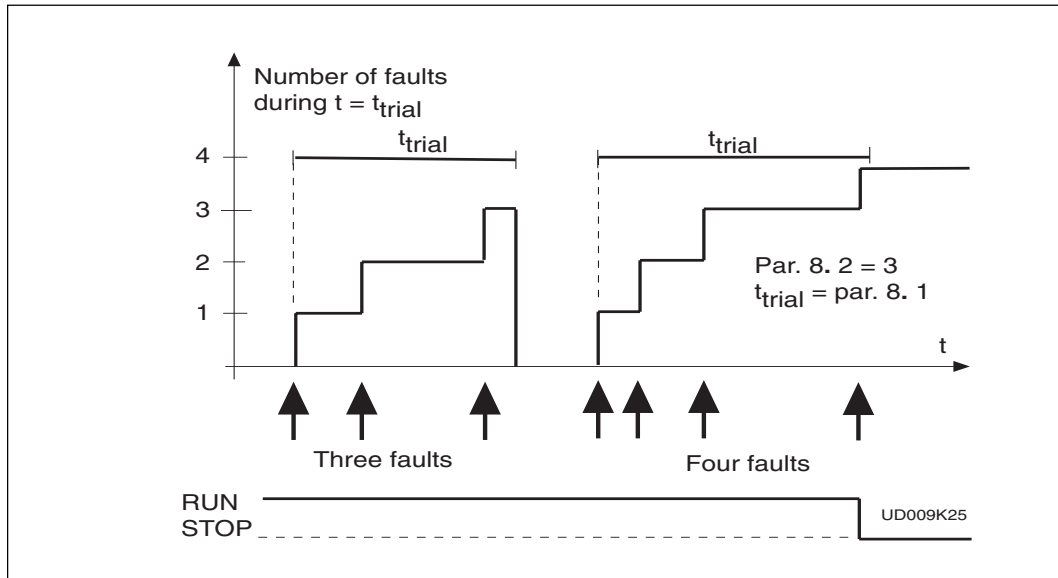

Figure 6-25 Automatic restart.

8.3 Automatic restart, start function

The parameter defines the start mode:

- 0 = Start with ramp
- 1 = Flying start, see parameter 4. 6.

8.4 Automatic restart after undervoltage trip

- 0 = No automatic restart after undervoltage trip
- 1 = Automatic restart after undervoltage fault condition returns to the normal condition (DC-link voltage returns to the normal level)

8.5 Automatic restart after overvoltage trip

- 0 = No automatic restart after overvoltage trip
- 1 = Automatic restart after overvoltage fault condition returns to the normal condition (DC-link voltage returns to the normal level)

8.6 Automatic restart after overcurrent trip

- 0 = No automatic restart after overcurrent trip
- 1 = Automatic restart after overcurrent faults

8.7 Automatic restart after reference fault trip

- 0 = No automatic restart after reference fault trip
- 1 = Automatic restart after analog current reference signal (4—20 mA) returns to the normal level (≥ 4 mA)

8.8 Automatic restart after over-/undertemperature fault trip

- 0 = No automatic restart after temperature fault trip
- 1 = Automatic restart after heatsink temperature has returned to its normal level between -10°C — $+75^{\circ}\text{C}$.

9. 1 Number of auxiliary drives

With this parameter the number of auxiliary drives in use will be defined. The signals controlling the auxiliary drives on and off can be programmed to relay outputs or to digital output with parameters 3. 6 - 3. 8. The default setting is one auxiliary drive in use and it is pre-programmed to relay output RO1.

9. 2 Start frequency of auxiliary drive 1

9. 4 Start frequency of auxiliary drive 2

9. 6 Start frequency of auxiliary drive 3

The frequency of the drive controlled by the frequency converter must exceed the limit defined with these parameters with 1 Hz before the auxiliary drive is started. The 1 Hz overdraft makes a hysteresis to avoid unnecessary starts and stops. See figure 6-26. **Notice!** See the parameter description par.1.1 and 1.2, page 6.

9. 3 Stop frequency of auxiliary drive 1

9. 5 Stop frequency of auxiliary drive 2

9. 7 Stop frequency of auxiliary drive 3

The frequency of the drive controlled by the frequency converter must fall with 1Hz below the limit defined with these parameters before the auxiliary drive is stopped. The stop frequency limit also defines the frequency to which the frequency of the drive controlled by the frequency converter is dropped after starting the auxiliary drive. See figure 6-26.

9. 10 Start delay of auxiliary drives

The frequency of the drive controlled by the frequency converter must exceed the start frequency of the auxiliary drive with the time defined with parameter 9. 10 before the drive is started. The delay is the same for all auxiliary drives. This prevents the unnecessary starts caused by momentary start limit exceedings. See figure 6-26.

9. 11 Stop delay of auxiliary drives

The frequency of the drive controlled by the frequency converter must fall below the stop limit of the auxiliary drive with the time defined with parameter 9. 11 before the drive is stopped. The delay is the same for all auxiliary drives. This prevents unnecessary stops caused by momentary falls below the stop limit. See figure 6-26.

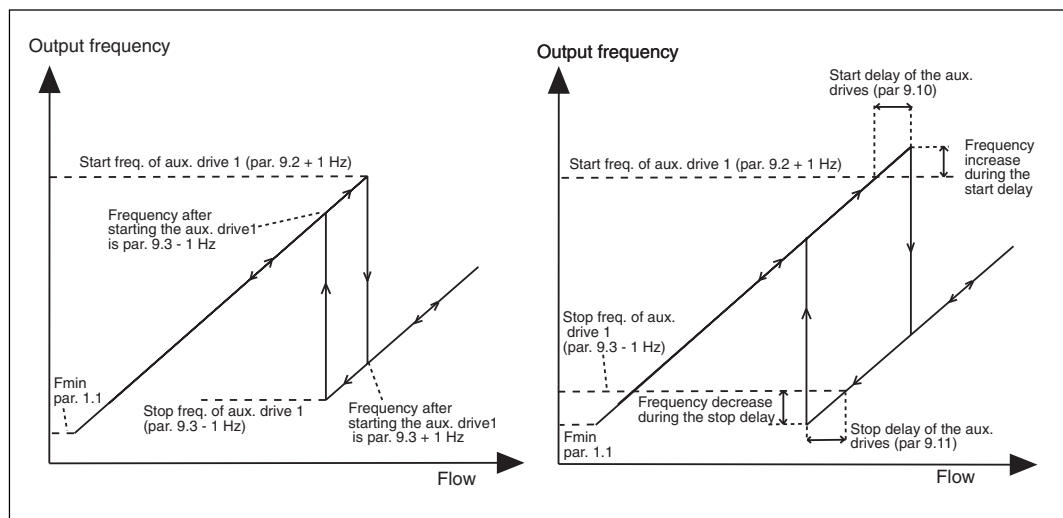

Figure 6-26 Example of effect of parameters in variable speed and one auxiliary drive system.

- 9.12 Reference step after start of the auxiliary drive 1
- 9.13 Reference step after start of the auxiliary drive 2
- 9.14 Reference step after start of the auxiliary drive 3
- 9.15 Reference step after start of the auxiliary drive 4

The reference step will be automatically added to the reference value always when the corresponding auxiliary drive is started. With the reference steps e.g. the pressure loss in the piping caused by the increased flow can be compensated. See figure 6-27.

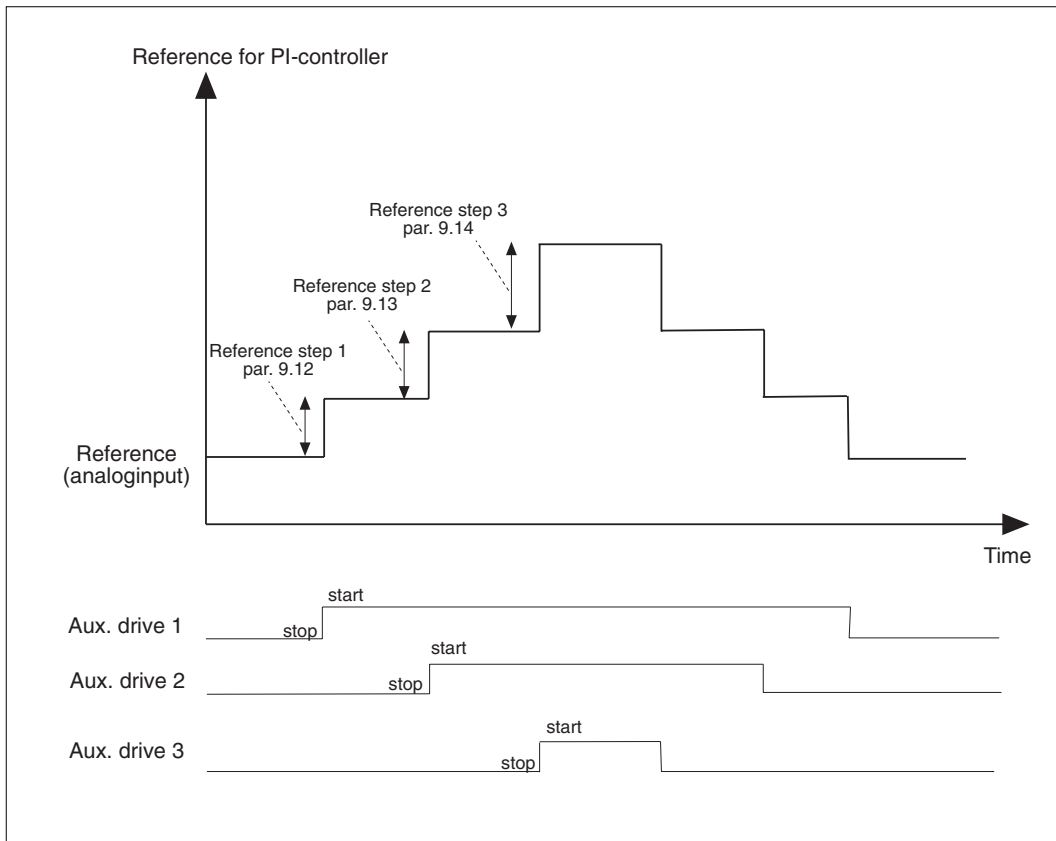

Figure 6-27 Reference steps after starting auxiliary drives.

9.16 Sleep level**9.17 Sleep delay**

The change of this parameter from value 0.0 Hz activates the sleep function where the frequency converter is stopped automatically when the frequency of the drive controlled by the frequency converter is below the sleep level (par. 9.16) continuously for the duration of the sleep delay (9.17). During the stop state the Pump and fan control is operating and it turns frequency converter to Run state when the wake up level defined with parameters 9.18 and 9.19 is reached. See figure 6-28.

9.18 Wake up level

The wake up level defines the level below which the actual value must fall or which has to be exceeded before starting the frequency converter from the sleep function. See figure 6-28.

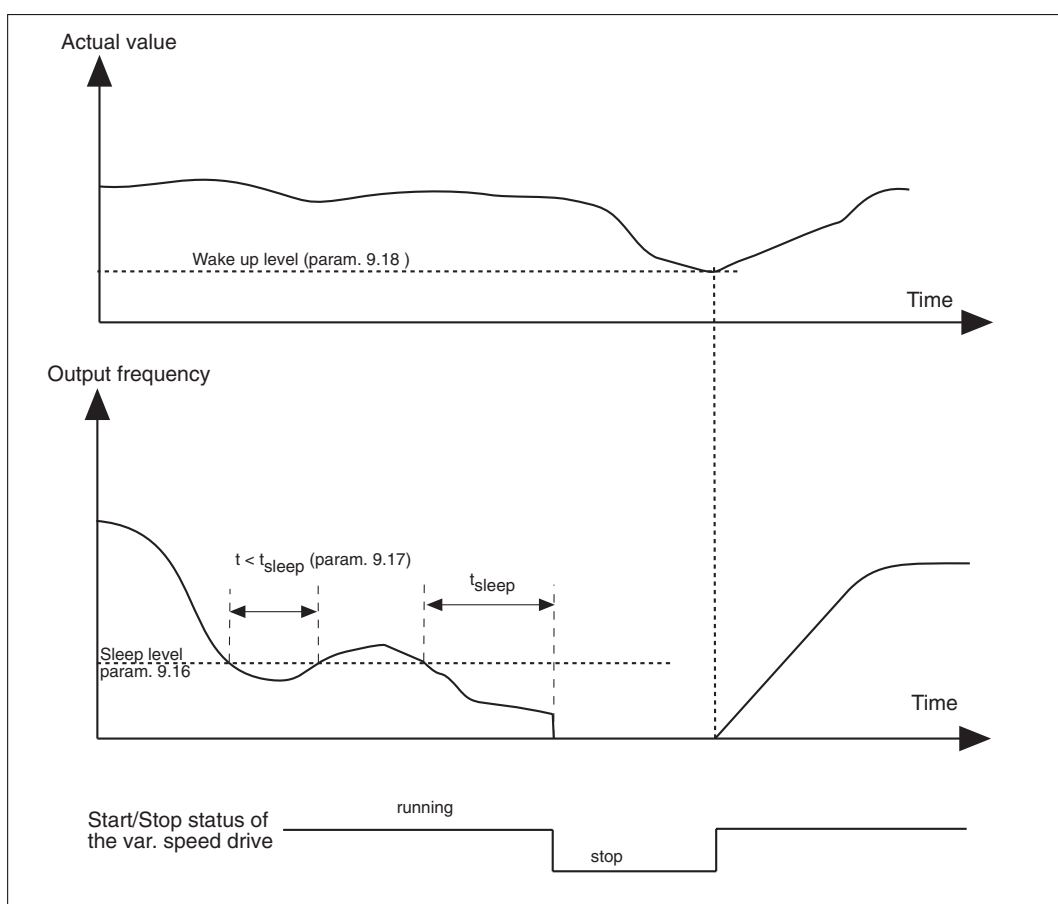

Figure 6-28 Example of the sleep function.

9.19 Wake up function

This parameter defines if the wake up occurs when the actual value signal falls below or exceeds the wake up level. Furthermore, it shall be selected if the level (Par. 9.18) is percents of maximum value of the actual value or percents of the current reference signal value.

Par. value	Function	Limit	Description
0	Wake up happens when actual value goes below the limit	The limit defined with parameter 9.18 is procents from the maximum value of the actual value	
1	Wake up happens when actual value exceeds the limit	The limit defined with parameter 9.18 is procents from the maximum value of the actual value	
2	Wake up happens when actual value goes below the limit	The limit defined with parameter 9.18 is procents from the current value of the reference signal	
3	Wake up happens when actual value exceeds the limit	The limit defined with parameter 9.18 is procents from the current value of the reference signal	

Table 6-3 Wake up function parameter selections

9. 20 PI-regulator bypass

With this parameter the PI-regulator can be programmed to be bypassed. Then the frequency of the drive controlled by the frequency converter and the starting points of the auxiliary drives are defined according to the actual value signal.

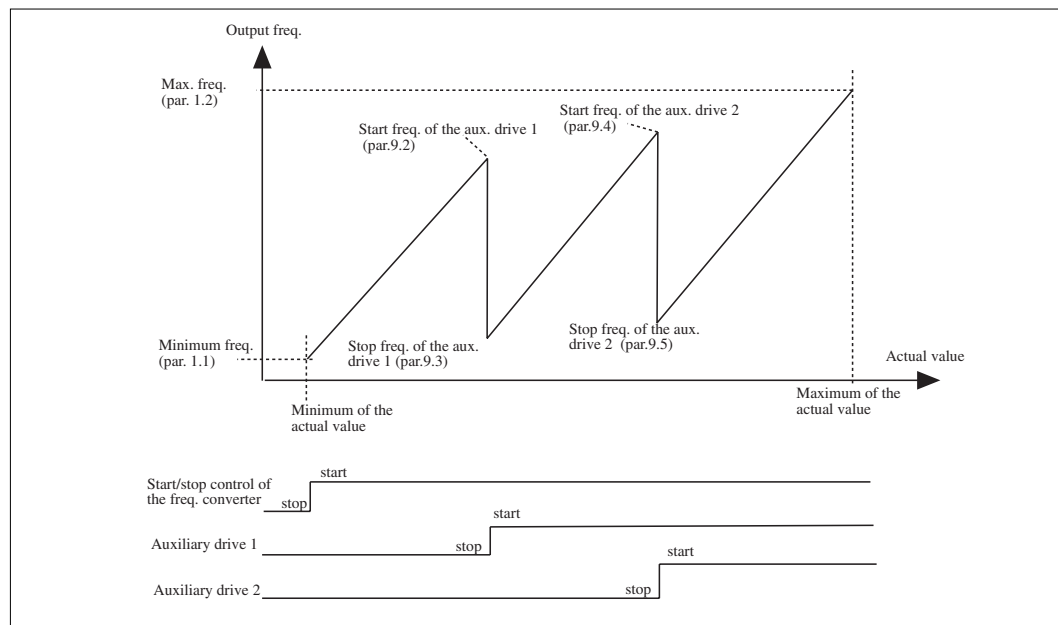

Figure 6-29 Example of the function of variable speed drive and two auxiliary drives when PI-regulator is bypassed with parameter 9. 20.

- 9. 21 Input pressure measurement analog input selection
- 9. 22 Input pressure high limit
- 9. 23 Input pressure low limit
- 9. 24 Output pressure drop value

In the pressure increase stations there may be need for decreasing the output pressure if the input pressure decreases below a certain limit. The function needs input pressure measurement that is connected to the analogue input selected with parameter 9.21. See figure 6-30.

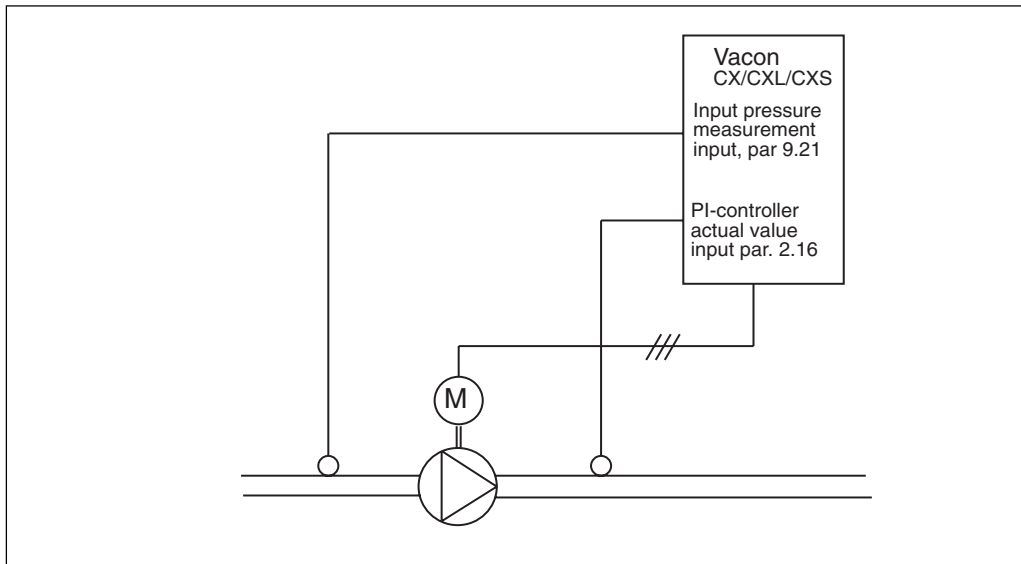

Figure 6-30 Output pressure decrease inputs

With parameters 9.22 and 9.23 the limits for the area of the input pressure, where the output pressure is decreased, can be selected. Values are in percentage of the input pressure measurement maximum value. With parameter 9.24 the value for output pressure decrease in this area can be set. The value is percents of the reference value maximum. See Figure 6-31.

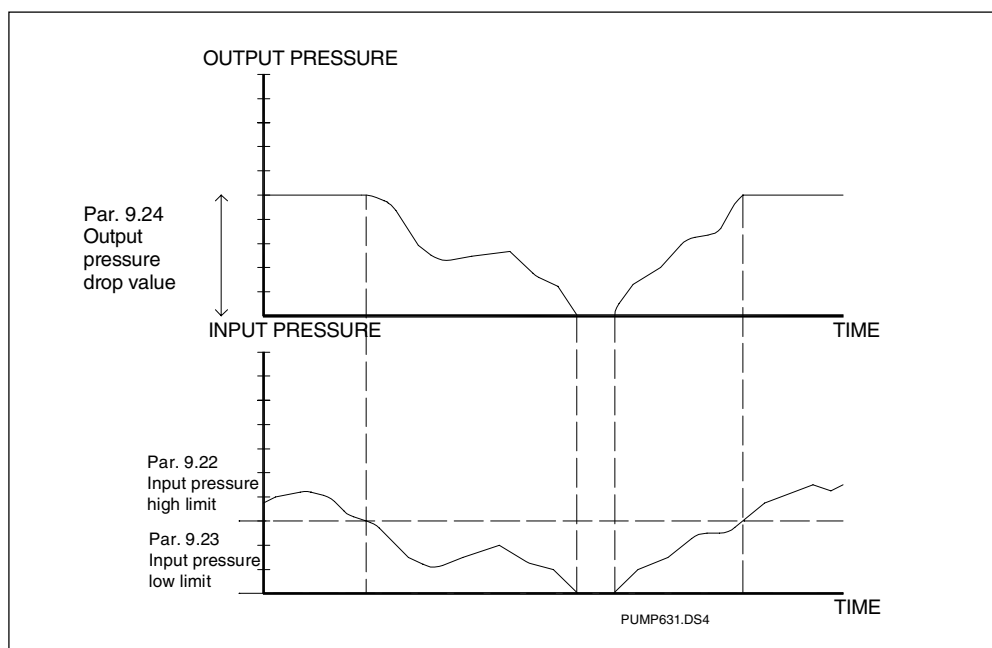

Figure 6-31 Output pressure function

9.25 Frequency drop delay after starting an auxiliary drive
9.26 Frequency increase delay after stopping an auxiliary drive

If the speed of auxiliary drive increases slowly (e.g. soft starter control) then a delay (par. 9.25) between auxiliary drive start and the frequency drop of the variable speed drive will make the control smoother.

Also if the speed of the auxiliary drives decreases slowly (soft starter control) then with parameter 9.26 a delay between auxiliary drive stop and the frequency increase of the variable speed drive can be programmed. See figure 6-32.

If either value of parameters 9.25 and 9.26 is maximum (300,0 s) then there is no frequency drop nor increase.

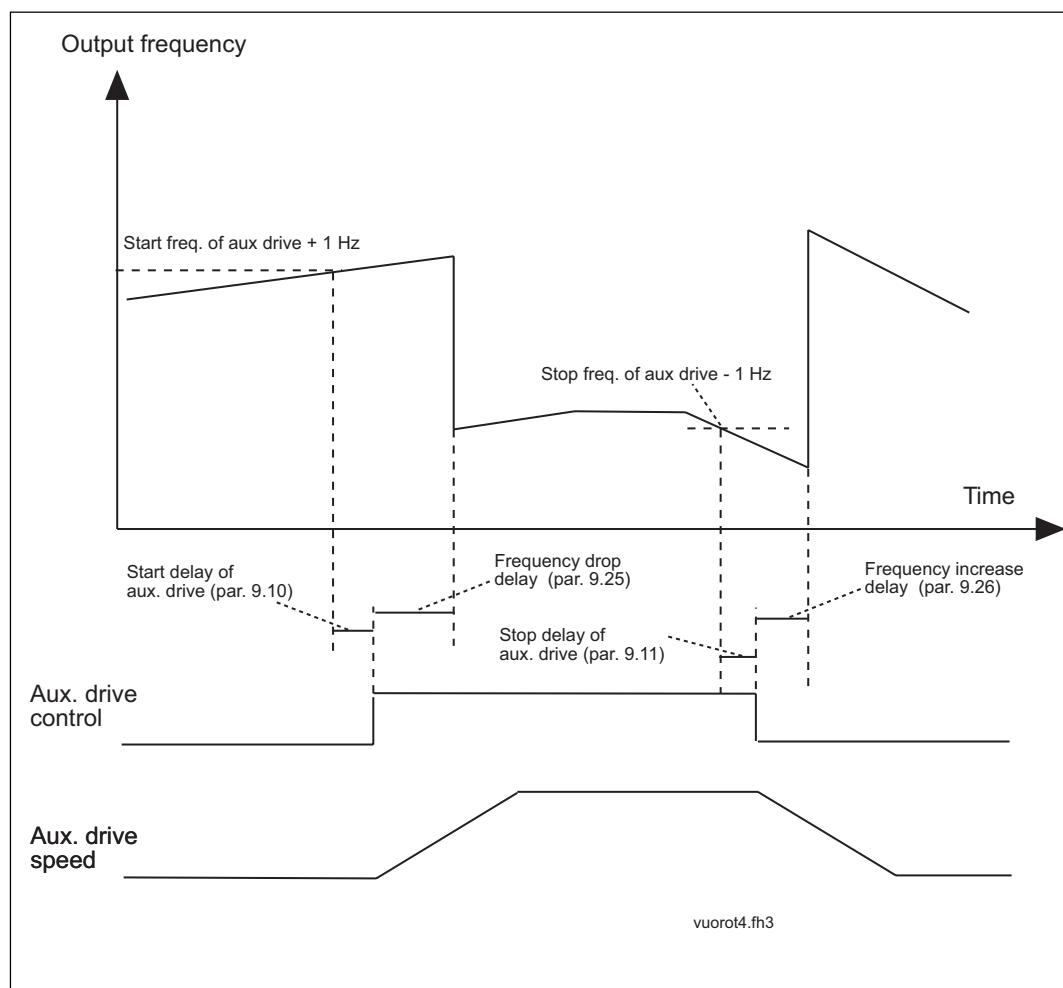

Figure 6-32 Frequency drop and increase delays

Autochange of drives

The autochange changes the start and stop order of the drives controlled by the pump- and fan control. Also the frequency converter controlled drive can be included in the autochange system. By using the autochange the running periods of the motors can be equal and e.g. the stalling of the pumps because of being unused for a long period can be prevented.

The autochange can be activated by selecting the autochange mode with parameter 9.27. The autochange happens when the time period set by parameter 9.28 is elapsed and the level of used capacity is below the limit defined with parameters 9.29 and 9.30. During the autochange moment all drives are stopped and then started with new order.

External contactors controlled by the relay outputs of the frequency converter connect the drives to the mains or to the frequency converter

9.27 Autochange mode

- 0 autochange not in use
- 1 Autochange is done by changing the starting order of the auxiliary drives. See figure 6-33.

The frequency converter controlled drive stays same. Only the mains contactor is needed for each drive.

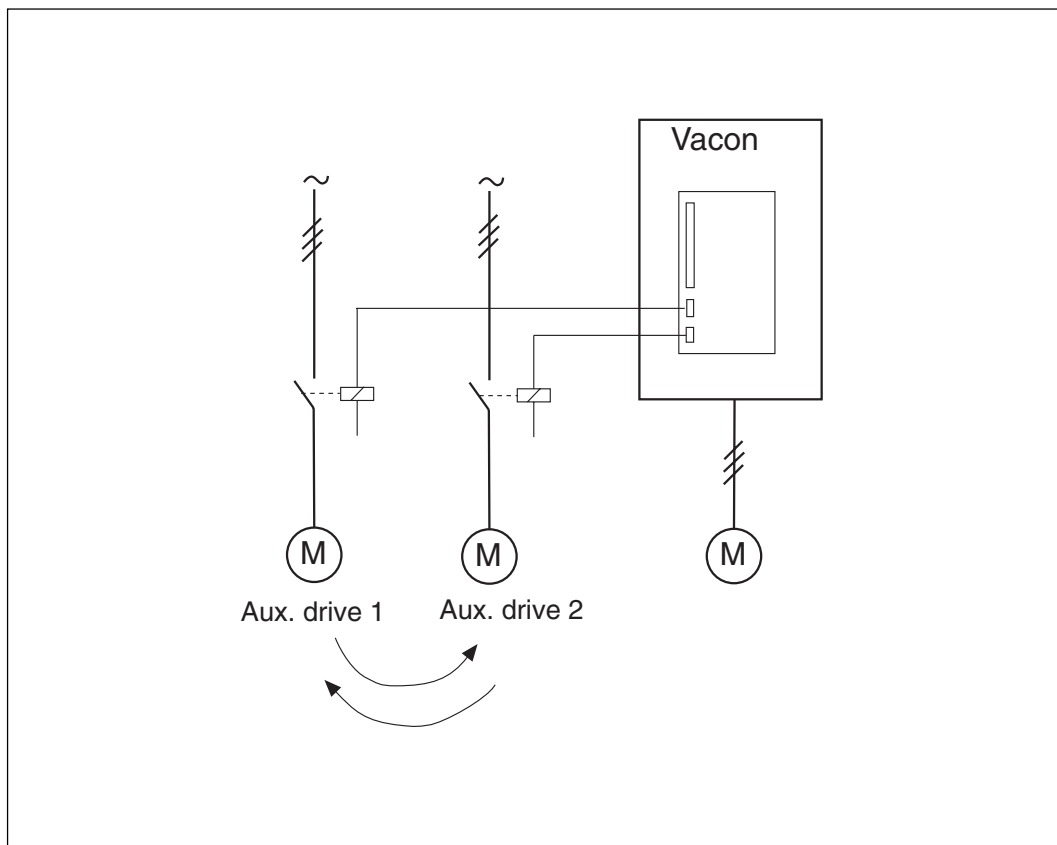

Figure 6-33 Autochange only with auxiliary drives

2 Autochange with all drives

Frequency converter drive is included in the autochange. For each drive a contactor for mains and another for frequency converter is needed. See figure 6-34.

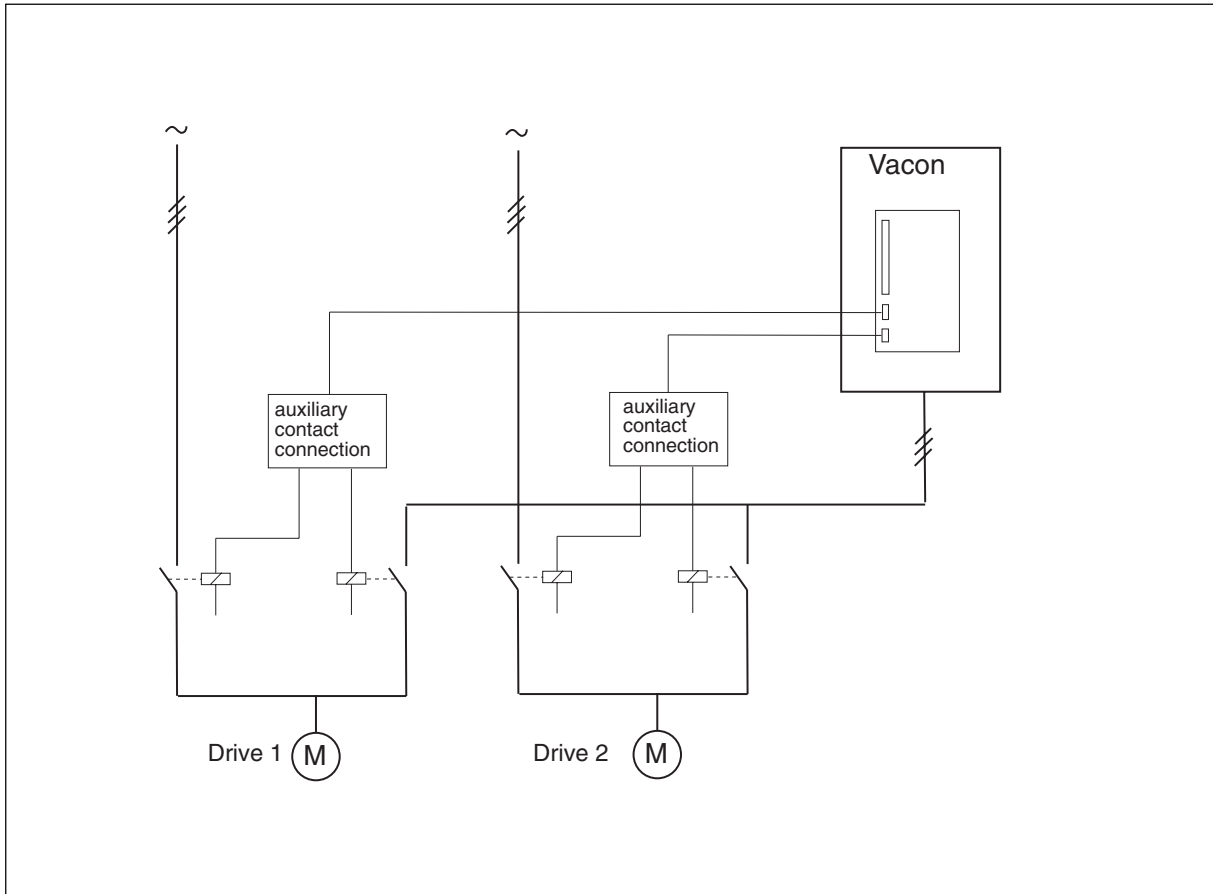

Figure 6-34 Autochange with all drives

9.28 Autochange interval

The parameter defines the time period after which the autochange will be done if the used capacity is below the limit defined with parameters 9.29 and 9.30. If the level is over the limit, wait the level to decrease below the limit before autochange execution. The next time period counting starts from the autochange execution. See figure 6-35.

9. 29 Autochange level, auxiliary drives
9. 30 Autochange level, variable speed drive frequency

These parameters define the level below which the used capacity must be when the autochange happens.

- * If the number of running auxiliary drives is less than the value of the parameter 9.29 the autochange can happen.
- * If the number of running auxiliary drives is equal to par. 9.29 and the frequency of the variable speed drive is less than the value of parameter 9.30 the autochange can happen.
- * If the parameter 9.30 = 0,0 Hz then the autochange can happen only in sleep or stop state in spite of the value of parameter 9.29.

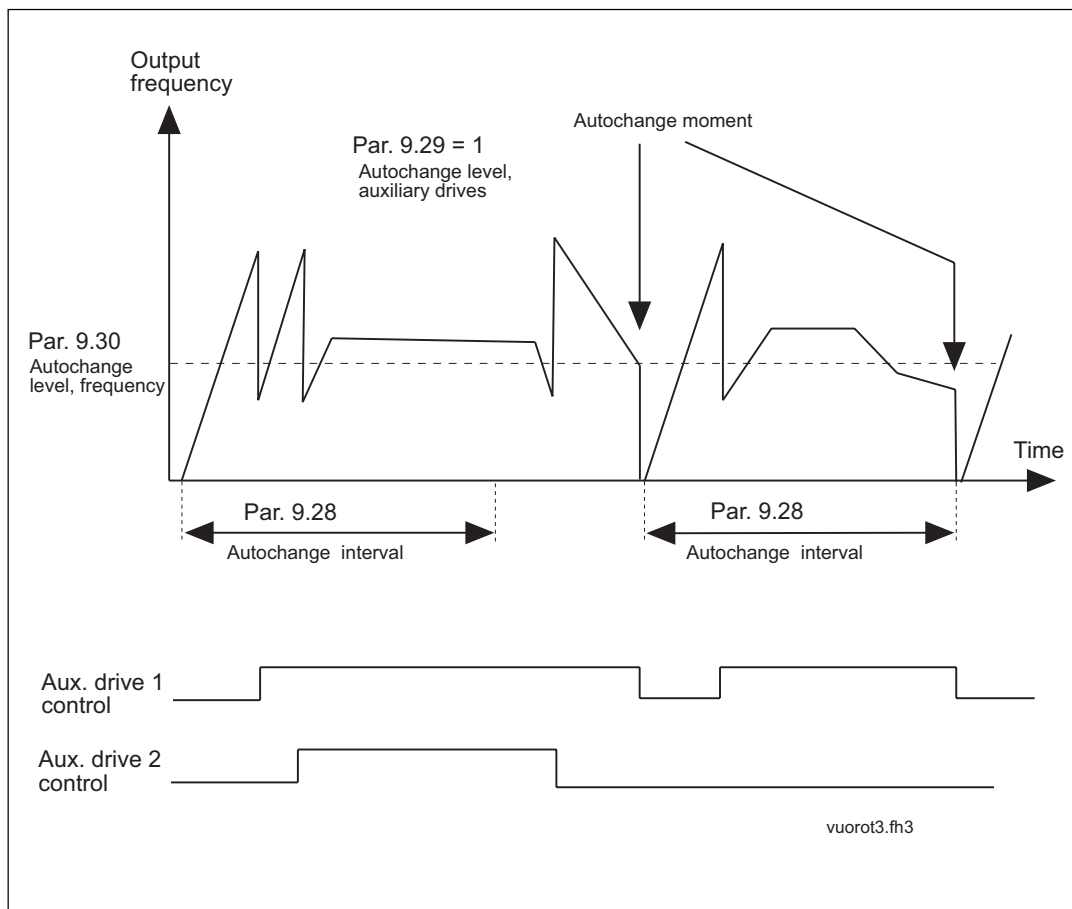

Kuva 6-35 Autochange interval and level

9. 31 Autochange interlocks

With this parameter the use of interlocks can be activated. The interlocks come from the switches that contact motors to the automatic control (frequency converter), off-state or directly to the mains. The interlock signals are connected to the digital inputs of the frequency converter. These inputs must be programmed to interlock inputs. Each drive must have own interlock input.

Pump- and fan control controls only those motors whose interlock input is active. If the interlock input changes to inactive or comes active again in Run state then pump and fan control stops all motors and then starts control with new composition.

If the intelock of auxiliary drives comes true via RUN mode, operation depends on par.9.35 setting. Default value is to restart the frequency converter and auxiliary drives after STOP taking with the drives in the regulator system (dig. input = ON). See par.9.35.

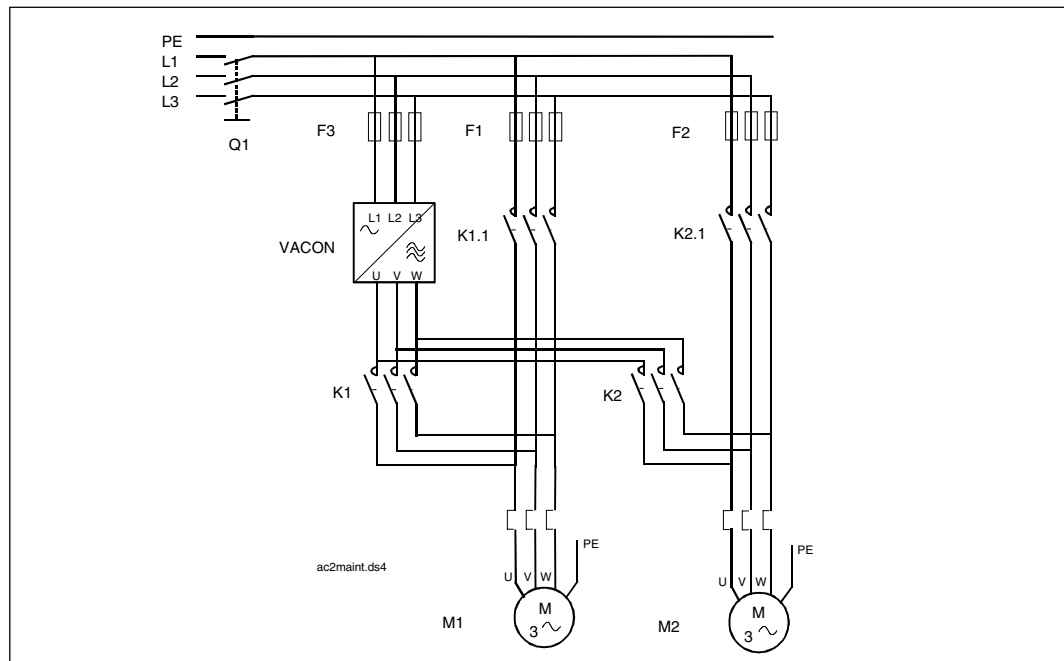

Figure 6-36 Example of two pump autochange, main diagram

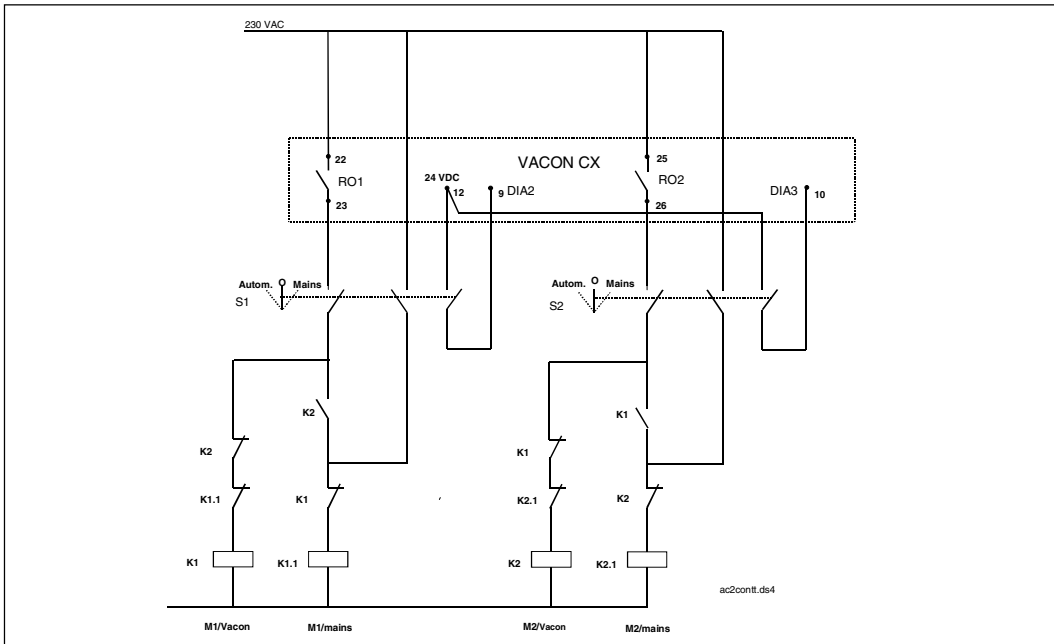

Figure 6-37 Principal control diagram of two-pump autochange

- 9. 32 Actual value special display minimum
- 9. 33 Actual value special display maximum
- 9. 34 Actual value special display, number of decimals

With these parameters the minimum and maximum values and also the number of decimals of the actual value special display can be set. The actual value can be found on the monitoring page with signal number n26.

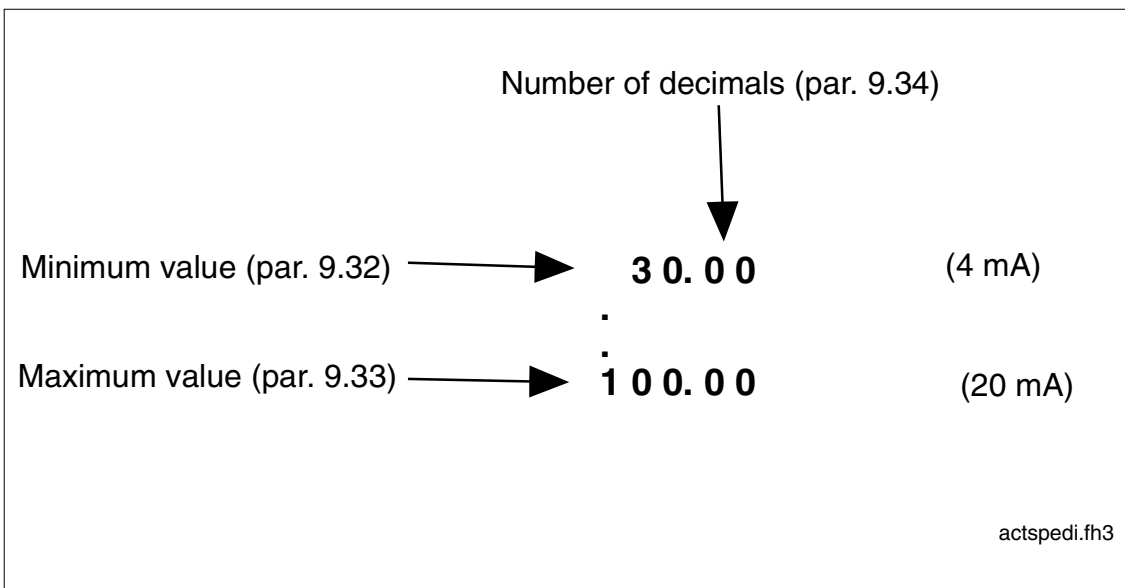

Figure 6-38 Actual value special display

9.35 Interlock update

Interlock update moment is selected when the dig. input comes true during RUN mode.

0: Update after autochange interval or in STOP state (f.eg. sleep function). During START state used drives (interlock TRUE) are taken with in the regulator system .

1: Update immediately. When the interlock comes TRUE the frequency converter and auxiliary drives are stopped. After this the frequency converter RERUN automatically taking with drives of regulator system when dig. input is ON.

When dig. input is OFF interlocked drive is stopped if it is in RUN state and it is removed from the regulator system. Frequency converter and other auxiliary drives are in RUN state.

10 Fieldbus control

Fieldbus control can be activated with parameter 10.1. Then the frequency or speed reference comes from the fieldbus as well as the Start/Stop and Reverse control.

First two parameters in group 10 concern all fieldbuses. Parameters 10.3 - 10.6 are only for Modbus, parameters 10.7 - 10.13 only for Profibus and 10.14 only for LONWorks.

10.1 Fieldbus control

Defines the active control source:

0: control via I/O terminals

1: control via Fieldbus board

Parameters 10.2 - 10.5 only for Modbus protocol

10.2 Slave address

Defines slave device address. Maximum value for this parameter is 247 and minimum is 1.

10.3 Baud rate

1: 300 baud

2: 600 baud

3: 1200 baud

4: 2400 baud

5: 4800 baud

6: 9600 baud

7: 19200 baud

10.4 Parity type

0: None

1: Even

2: Odd

10.5 Modbus time-out

The Modbus time-out determines how long the Fieldbus board waits for a message from a master device and is specific in seconds. Time can be set between 0 - 3600 s. Time 0 s = No time-out.

Parameters 10.6 - 10.12 only for Profibus DP protocol**10.6 Profibus slave address**

Defines slave device address. Maximum value for this parameter is 126 and minimum 2.

10.7 Profibus baud rate

- 1: 9.6 kbaud
- 2: 19.2 kbaud
- 3: 93.75 kbaud
- 4: 187.5 kbaud
- 5: 500 kbaud
- 6: 1.5 Mbaud
- 7: 3 Mbaud
- 8: 6 Mbaud
- 9: 12 Mbaud
- 10: AUTO (Automatic baud rate)

10.8 Profibus PPO Type

Selection of profibus PPO type.

- 1: PPO 1 (Parameter data 8 bytes, Control data 4 bytes)
- 2: PPO 2 (Parameter data 8 bytes, Control data 4 bytes)
- 3: PPO 3 (Control data 4 bytes)
- 4: PPO 4 (Control data 12 bytes)

10.9 Profibus process Data 1**10.10 Profibus process Data 2****10.11 Profibus process Data 3****10.12 Profibus process Data 4**

Selection of profibus process data source.

Value 1 . . . 22 Number of actual value (=n1 . . . n22 in monitoring page).

Value 99 Active fault code.

Parameter 10.13 only for LONWorks protocol**10.14 LONWorks service button**

Changing the value of this parameter from 0 to 1 or vice versa and pressing the Enter button cause the unique LONWorks ID number to be sent to the network.

7 I/O-expander with pump and fan control application

The digital inputs and relay outputs of the I/O-expander board has fixed signals according to figure 6-1 when the pump and fan control application is selected.

Digital inputs are used for interlock inputs and they all or part of them are active if the use of interlocks is set active with parameter 9.31. Number of auxiliary drives (par, 9.1) defines how many inputs are active. The controls of auxiliary drives are connected to relay outputs. If four- or five-pump autochange is in use then the relay outputs of the basic control board can be used additionally.

Terminal	Signal	Description
201	+10V _{ref}	Reference output Voltage for a potentiometer, etc.
202	U _{in+}	Analogue input, voltage range 0—10 V DC Programmable (Default: Not in use)
203	GND	I/O ground Ground for reference and controls
204	I _{in+}	Analogue input, current range 0—20 mA Programmable (Default: Not in use)
205	I _{in-}	
206	+24V	Control voltage output Voltage for switches, etc. max. 0.1 A
207	GND	I/O ground Ground for reference and controls
208	CMC	Common for DIC1-DIC7 Connect to GND or + 24 V
209	DIC1	Interlock input, autochange 1 Contact closed = interlock is active
210	DIC2	Interlock input autochange 2 Contact closed = interlock is active
211	DIC3	Interlock input, autochange 3 Contact closed = interlock is active
212	DIC4	Interlock input autochange 4 Contact closed = interlock is active
213	DIC5	Interlock input, autochange 5 Contact closed = interlock is active
214	DI6A+	Pulse input A (differential input)
215	DI6A-	
216	DI7B+	Pulse input B (differential input) 90 degrees phase shift compared to pulse input A
217	DI7B-	
218	DI8Z+	Pulse input C (differential input) one pulse per one revolution
219	DI8Z-	
220	I _{out+}	Analogue output Programmable Range 0—20 mA/R _L max. 500 Ω
221	TI+	Termistor input
222	TI-	
223	RO3	Relay output 3 Aux. drive 1 / Autochange 1 control
224	RO3	
225	RO4	Relay output 4 Aux. drive 2 / Autochange 2 control
226	RO4	
227	RO5	Relay output 5 Aux. drive 3 / Autochange 3 control
228	RO5	

Figure 7-1 I/O-expander with pump and fan control application

Terminal	Signal	Description
206	+24V	Control voltage output Voltage for switches, etc. max. 0.1 A
207	GND	I/O ground Ground for reference and controls
208	CMC	Common for DIC1-DIC7 Connect to GND or + 24 V
209	DIC1	Interlock input, autochange 1 Contact closed = interlock is active
210	DIC2	Interlock input autochange 2 Contact closed = interlock is active
211	DIC3	Interlock input, autochange 3 Contact closed = interlock is active
212	DIC4	Interlock input autochange 4 Contact closed = interlock is active
213	DIC5	Interlock input, autochange 5 Contact closed = interlock is active
214	GND	I/O ground Ground for reference and controls
215	I _{out} +	Analogue output Programmable Range 0—20 mA /R _L max. 500 Ω
221	TI+	Termistor input
222	TI-	
223	RO3	Relay output 3 Aux. drive 1 / Autochange 1 control
224	RO3	
225	RO4	Relay output 4 Aux. drive 2 / Autochange 2 control
226	RO4	
227	RO5	Relay output 5 Aux. drive 3 / Autochange 3 control
228	RO5	

Figure 7-2 I/O-Expander 103 OPT with pump and fan control

Terminal	Signal	Description
206	+24V	Control voltage output Voltage for switches, etc. max. 0.1 A
207	GND	I/O ground Ground for reference and controls
208	COME	Common for DIC1-DIC7 Connect to GND or + 24 V
209	DIE1	Interlock input, autochange 1 Contact closed = interlock is active
210	DIE2	Interlock input autochange 2 Contact closed = interlock is active
211	DIE3	Interlock input, autochange 3 Contact closed = interlock is active
212	DIE4	Interlock input autochange 4 Contact closed = interlock is active
213		Not used
214	DIE6A+	Interlock input autochange 5 Contact closed = interlock is active
215	DIE6A-	
216	DIE7B+	
217	DIE7B-	
218	DOE1	
219	DOE2	
220		Not used
221	TI+	Termistor input
222	TI-	
225	RO4/1	Aux. drive 3 / autochange 3 control
226	RO4/2	
231	DOE3	Open collector output 3 Aux. drive 1 / autochange 1 control
232	GND	I/O ground
233	DOE4	Open collector output 4 Aux. drive 2 / autochange 2 control
234	GND	I/O ground

Figure 7-2 I/O-Expander 202OPT with pump and fan control (Profibus)

NOTE! Termistor input (terminals 327 and 328) must be shorted if not used.
 READY = ON, when mains voltage has been applied and Vacon CX is ready to operate.
 RUN = ON, when motor is running.
 FAULT = ON, if a fault occurs.
 FIELDBUS CONTROL = ON, when the fieldbus board is the Active Control Source.

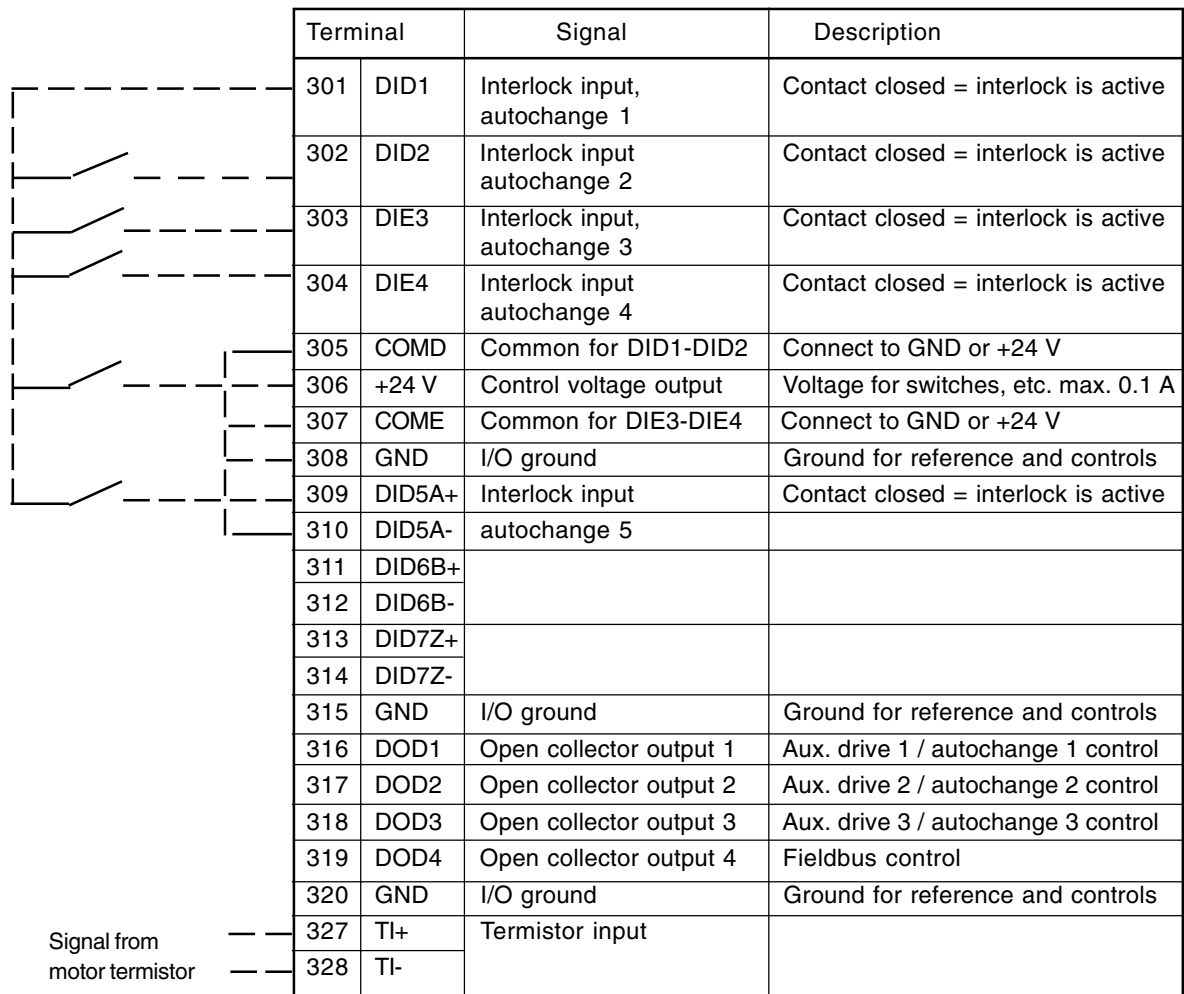

Figure 7-3 I/O-Expander 201OPT with pump and fan control (Modbus)

NOTE! Termistor input (terminals 327 and 328) must be shorted if not used.
 READY = ON, when mains voltage has been applied and Vacon CX is ready to operate.
 RUN = ON, when motor is running.
 FAULT = ON, if a fault occurs.

Terminal	Signal	Description
301	DID1	Interlock input, autochange 1 Contact closed = interlock is active
302	DID2	Interlock input autochange 2 Contact closed = interlock is active
303	DIE3	Interlock input, autochange 3 Contact closed = interlock is active
304	DIE4	Interlock input autochange 4 Contact closed = interlock is active
305	COMD	Common for DID1-DID2 Connect to GND or +24 V
306	+24 V	Control voltage output Voltage for switches, etc. max. 0.1 A
307	COME	Common for DIE3-DIE4 Connect to GND or +24 V
308	GND	I/O ground Ground for reference and controls
309	DID5A+	Interlock input Contact closed = interlock is active
310	DID5A-	autochange 5
311	DID6B+	
312	DID6B-	
313	DID7Z+	
314	DID7Z-	
315	GND	I/O ground Ground for reference and controls
316	DOD1	Open collector output 1 Aux. drive 1 / autochange 1 control
317	DOD2	Open collector output 2 Aux. drive 2 / autochange 2 control
318	DOD3	Open collector output 3 Aux. drive 3 / autochange 3 control
319	DOD4	Open collector output 4 Fieldbus control
320	GND	I/O ground Ground for reference and controls
327	TI+	Termistor input
328	TI-	
329		LONWorks network
330		

Figure 7-4 I/O-Expander 203OPT with pump and fan control (LONWorks)

NOTE! Termistor input (terminals 327 and 328) must be shorted if not used.
 READY = ON, when mains voltage has been applied and Vacon CX is ready to operate.
 RUN = ON, when motor is running.
 FAULT = ON, if a fault occurs.

Terminal	Signal	Description
301	DID1	External fault (closing contact) Contact open = no fault Contact closed = fault
302	DID2	RUN disable Contact open=start of motor enable Contact closed=start of motor disabled
303	DID3	Acceler. / Decel. time selection Contact open = time 1 selected Contact closed = time 2 selected
304	DID4	Jogging speed selection Contact open = no action Contact closed = jogging speed
305	COMD	Common for DID1-DID2 Connect to GND or +24 V
306	+24 V	Control voltage output Voltage for switches, etc. max. 0.1 A
307	COME	Common for DIE3-DIE4 Connect to GND or +24 V
308	GND	I/O ground Ground for reference and controls
309	DID5A+	Pulse input A (differential input)
310	DID5A-	
311	DID6B+	Pulse input B (differential input) 90 degrees phase shift compared to pulse input A
312	DID6B-	
313	DID7Z+	Pulse input Z (differential input) one pulse per one revolution
314	DID7Z-	
315	GND	I/O ground Ground for reference and controls
316	DOD1	Open collector output 1 Aux. drive 1 / autochange 1 control
317	DOD2	Open collector output 2 Aux. drive 2 / autochange 2 control
318	DOD3	Open collector output 3 Aux. drive 3 / autochange 3 control
319	DOD4	Open collector output 4 Fieldbus control
320	GND	I/O ground Ground for reference and controls
327	TI+	Termistor input
328	TI-	

Figure 7-5 I/O-Expander 200OPT with pump and fan control (Interbus-S)

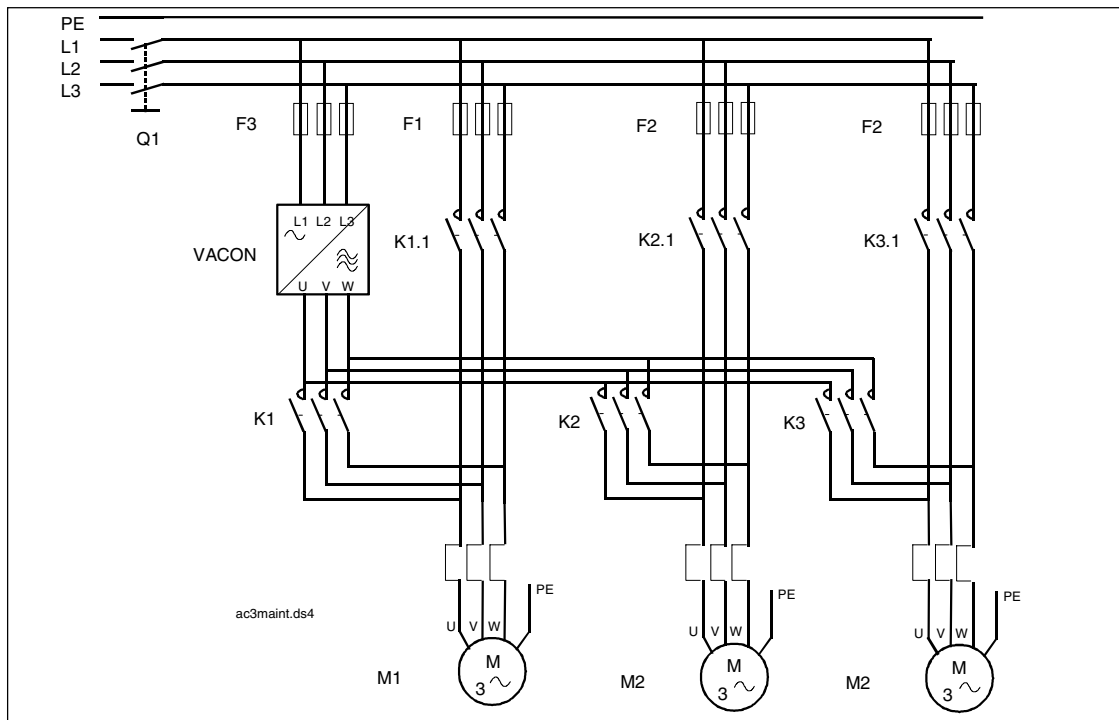

Figure 7-6 Example of 3-pump autochange system, main diagram

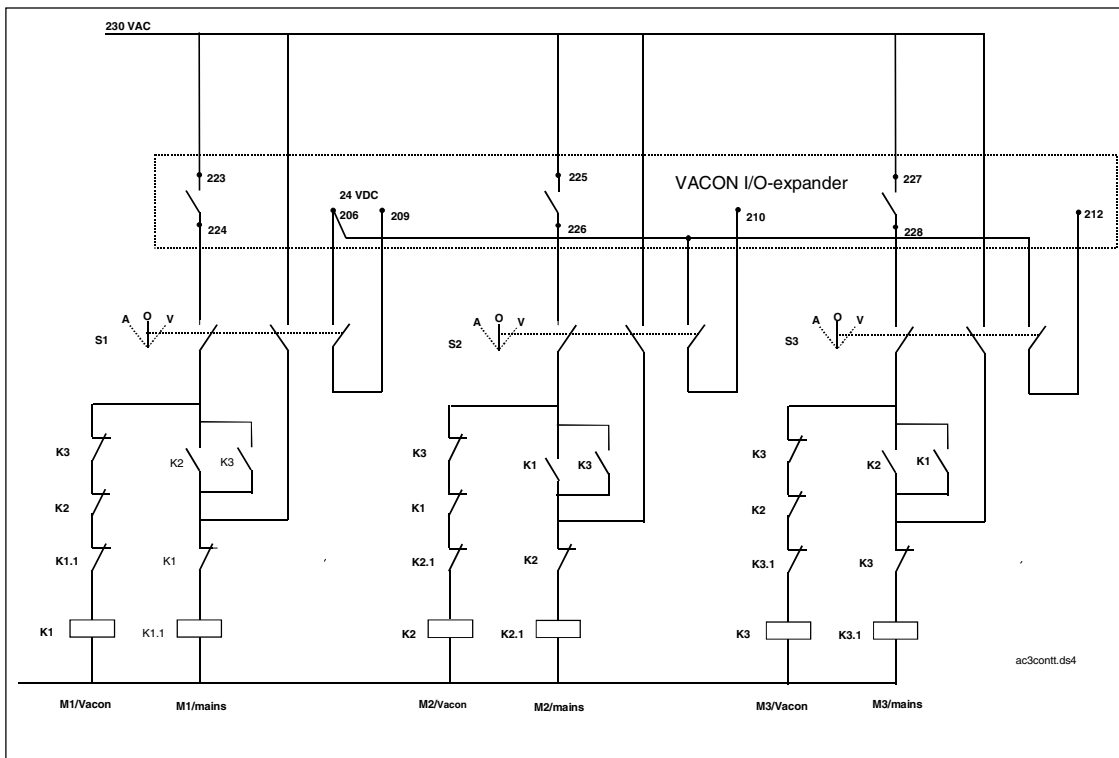

Figure 7-7 Principal control diagram of 3-pump autochange system

8 Commissioning of pump- and fan control application

General

1. Set motor name plate data, supply voltage and other parameters if necessary.
2. Set the number of auxiliary drives
3. If needed change the start and stop limits of the auxiliary drives as well as start and stop delays of auxiliary drives

Autochange not in use

- 4A. Program the relay outputs and digital output according to the number of auxiliary drives. Set own output for each drive with parameters 3.6 - 3.8.
The value of the parameter will be Aux. drive 1, Aux. drive 2 or Aux. drive 3

Autochange in use

- 4B. Program the relay outputs and digital output according to the number of auxiliary drives by setting values of parameters 3.6 - 3.8 to:
3.6 = Autochange 3 control (27) , Digital output
3.7 = Autochange 1 control (26) , Relay output 1
3.8 = Autochange 2 control (26) , Relay output 2

If the Autochange is only with auxiliary drives (par. 9.27 =1) then the outputs are auxiliary drive control signals. In the beginning the Autochange 1 control is the control signal of the first auxiliary drive.

If all drives are included to the autochange (par. 9.27 = 2) then the outputs are control signals of the frequency converter controlled drive and auxiliary drives. In the beginning the Autochange 1 control is the control signal of the frequency converter controlled drive

- 5B. Program the autochange interval (par. 9.28) and proper capacity level (par. 9.29 and par 9.30) that can be in use when the Autochange happens.
- 6B. If interlocks are used then set the function active with parameter 9.31. Program own interlock input for each drive. If I/O-expander is in use it has interlock inputs as constant and the inputs of basic control board are not needed.

9 MONITORING DATA

The PI-control application has extra items for monitoring (V20 - V26). See table 9-1

Data number	Data name	Unit	Description
V1	Output frequency	Hz	Frequency to the motor
V2	Motor speed	rpm	Calculated motor speed
V3	Motor current	A	Measured motor current
V4	Motor torque	%	Calculated actual torque/nominal torque of the unit
V5	Motor power	%	Calculated actual power/nominal power of the unit
V6	Motor voltage	V	Calculated motor voltage
V7	DC-link voltage	V	Measured DC-link voltage
V8	Temperature	°C	Temperature of the heat sink
V9	Operating day counter	DD.dd	Operating days ¹⁾ , not resettable
V10	Operating hours, "trip counter"	HH.hh	Operating hours ²⁾ , can be reset with programmable button #3
V11	MW-hours	MWh	Total MW-hours, not resettable
V12	MW-hours, "trip counter"	MWh	MW-hours, can be reset with programmable button #4
V13	Voltage/analogue input	V	Voltage of the terminal U _{in+} (term. #2)
V14	Current/analogue input	mA	Current of terminals I _{in+} and I _{in-} (term. #4, #5)
V15	Digital input status, gr. A		
V16	Digital input status, gr. B		
V17	Digital and relay output status		
V18	Control program		Version number of the control software
V19	Unit nominal power	kW	Shows the power size of the unit
V20	PI-controller reference	%	Percents of the maximum reference
V21	PI-controller actual value	%	Percents of the maximum actual value
V22	PI-controller error value	%	Percents of the maximum error value
V23	PI-controller output	Hz	
V24	Number of running auxiliary drives		
V25	Motor temperature rise	%	100%= temperature of motor has risen to nominal
V26	Actual value special display		Minimum and maximum values and number of decimals is defined with parameters 9.32 - 9.34
V27	Digital input OPT 1 - 3		See V15, V16, V17
V28	Digital input OPT 4 - 5		See V15, V16, V17
V29	Digital and relay output OPT		See V15, V16, V17

Table 9-1 Monitored items.

¹⁾ DD = full days, dd = desimal part of a day

²⁾ HH = full hours, hh = desimal part of an hour

10 Panel reference

The Pump and fan control application has extra references (r2 and r3) for PI-controller on the panel's reference page. See table 10-1.

Reference number	reference name	range	step	Function
r1	Frequency reference	$f_{\min}—f_{\max}$	0.01 Hz	Reference for panel control and I/O terminal Source B reference.
r2	PI-controller reference	0—100%	0.1%	Reference for PI-controller
r3	PI-controller reference	0—100 %	0,1 %	Reference for PI-controller - Can be programmed to PI-controller reference 2 that can be selected with digital input.

Table 10-1 Panel reference.

vacon

VACON PLC
P.O. Box 25
Runsorintie 7
FIN-65381 VAASA
FINLAND

Phone: +358-201 2121

Fax: +358-201-212 205

Service: +358-40-8371 150

E-mail: vacon@vacon.com

<http://www.vacon.com>

Distributor: